

American DJ®

EMERALD SCAN II



User Instructions

Emerald Scan II

General Introduction

Introduction: Thank you for purchasing the American DJ® Emerald Scan II. The Emerald Scan II is a DMX intelligent, laser effect that creates multiple patterns. This unit can be used as a stand alone, sound-active unit or in a Master/Slave configuration. The unit can also be controlled via DMX controller. For a dramatic laser show use several Emerald Scan II's together. This piece is best used with a fog or haze machine to enhance the beam output.

Unpacking: Every Emerald Scan II has been thoroughly tested and has been shipped in perfect operating condition. Carefully check the shipping carton for damage that may have occurred during shipping. If the carton appears to be damaged, carefully inspect the unit for any damage and be sure all accessories necessary to operate the unit have arrived intact. In the event damage has been found or parts are missing, please contact our toll free customer support number for further instructions. Please do not return the unit to your dealer without first contacting customer support.

Customer Support: American DJ® provides a toll free customer support line, to provide set up help and to answer any question should you encounter problems during your set up or initial operation. You may also visit us on the web at www.americandj.com for any comments or suggestions. *For service related issue please contact American DJ®.* Service Hours are Monday through Friday 9:00 a.m. to 5:00 p.m. Pacific Standard Time.

Voice: (800) 322-6337

Fax: (323) 582-2941

E-mail: support@americandj.com

To purchase parts online visit <http://parts.americandj.com>

Warning! To prevent or reduce the risk of electrical shock or fire, do not expose this unit to rain or moisture.

Caution! There are no user serviceable parts inside this unit. Do not attempt any repairs yourself, doing so will void your manufactures warranty. In the unlikely event your unit may require service please contact American DJ customer support.

PLEASE recycle the shipping carton whenever possible.

Emerald Scan II

General Instructions

Please carefully read and understand the instructions in this manual thoroughly before attempting to operate this unit. These instructions contain important safety information regarding the use and maintenance of this unit. Please keep this manual with the unit, for future reference.

CAUTION IMPORTANT! When installing this projector, make sure that it is mounted in a manner that prevents the audience from looking directly into the beam, and the beam from striking the audience.

Emerald Scan II

Features

- 4.9mW Green Laser Diode
- X/Y Mirror Control
- 5 Channel DMX Control
- Built-In Hanging Yoke
- Sound Active with Internal Microphone
- Fan Cooled
- Multiple Patterns
- BC 30 Controller (Not Included)

Emerald Scan II

Warranty Registration

The Emerald Scan II carries a 90 day limited warranty. Please fill out the enclosed warranty card to validate your purchase. All returned service items whether under warranty or not, must be freight pre-paid and accompany a return authorization (R.A.) number. If the unit is under warranty you must provide a copy of your proof of purchase invoice. Please contact American DJ® customer support for a R.A. number.

Emerald Scan II

Safety Precautions



Safety Issues: This unit may “pop” the breaker if the maximum allotted load of 2 amps is reached.

- To reduce the risk of electrical shock or fire, do not expose this unit rain or moisture.
- Do not spill water or other liquids into or on to your unit.
- Do not attempt to remove or break off the ground prong from the electrical cord. This prong is used to reduce the risk of electrical shock and fire in case of an internal short. Do not attempt to operate this unit if the power cord has been frayed or broken.
- Disconnect from main power before making any type of connection.
- Do not remove the cover under any conditions. There are no user serviceable parts inside.
- Always be sure to mount this unit in an area that will allow proper ventilation. Allow about 6” (15cm) between this device and a wall.
- Do not attempt to operate this unit, if it becomes damaged.
- This unit is intended for indoor use only, use of this product outdoors voids all warranties.
- During long periods of non-use, disconnect the unit’s main power.
- Always mount this unit in safe and stable matter.
- Power cords should be routed so they are not likely to be walked on, pinched by items placed upon or against them.
- Cleaning -The fixture should be cleaned only as recommended by the manufacturer. See page 14 for cleaning details.
- Heat -The appliance should be situated away from heat sources such as radiators, heat registers, stoves, or other appliances (including amplifiers) that produce heat.
- The fixture should be serviced by qualified service personnel when:
 - A. The power-supply cord or the plug has been damaged.
 - B. Objects have fallen, or liquid has been spilled into the unit.
 - C. The unit has been exposed to rain or water.
 - D. The unit does not appear to operate normally or exhibits a marked change in performance.

NON-INTERLOCKED HOUSING WARNING

The Emerald Scan II contains high power laser devices internally. **Do not** open the laser housing, due to the potential exposure to unsafe levels of laser radiation. The laser power levels, if the unit is opened, can cause instant blindness, skin burns and fires.

**STOP AND READ ALL LASER SAFETY DATA
OPERATION INSTRUCTIONS AND LASER SAFETY**

The light source emitted from this product can potentially cause eye injury if not set up and used properly. The light source emitted from a laser is very different from any other light sources with which you may be aware of. Laser light is thousands of times more concentrated than any light from any other kind of light source. This concentration of light can cause instant eye injuries, primarily by burning the retina (the back of your eyeball containing cells that are sensitive to light). Even if you cannot feel “heat” from a laser beam, it can still potentially injure or blind you or your audience. Even very small amounts of laser beam light are potentially hazardous even at long distances. Laser eye injuries can be sustained faster than you can blink.

Do not think that because this laser splits the laser beam into hundreds of beams and that the laser beam is scanned out in high speed, that an individual laser beam is safe for eye exposure. This laser uses dozens of milliwatts of laser power (Class 3B levels internally) before it splits into multiple beams (Class 3R levels). Many of the individual beams are potentially hazardous to the eyes.

Do not think that because the laser light is moving, it is safe. This is not true. Nor, do the laser beams always move. Since eye injuries can occur instantly, it is critical to prevent even the smallest possibility of any direct eye exposure. In the laser safety regulation, it is not legal to aim Class 3R lasers in areas which people can get exposed. This is true even if it is aimed below people’s faces, such as on a dance floor.

Do not operate the laser without first reading and understanding all safety and technical data in this manual.

Always set up and install all laser effects so that all laser light is at least 3 meters (9.8 feet) above the floor on which people can stand.

After setting up, and before public use, test laser to ensure proper function. Do not use if any defect is detected. Do not use if laser emits only one or two laser beams rather than dozens/hundreds, as this could indicate damage to the diffraction grating optic, and could allow emission of higher laser levels above Class 3R.

Do not point lasers at people or animals. Never look into the laser aperture or laser beams.

Do not point lasers in areas in which people can potentially get exposed, such as uncontrolled balconies, etc.

Do not point lasers at highly reflective surfaces, such as windows, mirrors and shiny metal. Even laser reflections can be hazardous.

Never point a laser at aircraft, this is a federal offense.

Never point un-terminated laser beams into the sky.

Do not expose the output optic (aperture) to cleaning chemicals.

Do not use laser if the laser appears to be emitting only one or two beams.

Do not use the laser if the housing is damaged, the housing is open, or if the optics appear damaged in any way.

Never open the laser housing. The high laser power levels inside of the protective housing can start fires, burn skin and will cause instant eye injury.

Never leave this device running unattended.

The operation of a class 3R laser show is only allowed if the show is controlled by a skilled and well- trained operator, familiar with the data included in this manual.

The legal requirements for using laser entertainment products vary from country to country. The user is responsible for the legal requirements at the location/country of use.

Always use proper lighting safety cables when hanging lights and effects overhead.



**LASER
APERTURE**

**CAUTION - CLASS 3R
LASER RADIATION
WHEN OPEN. AVOID
EXPOSURE TO BEAM**

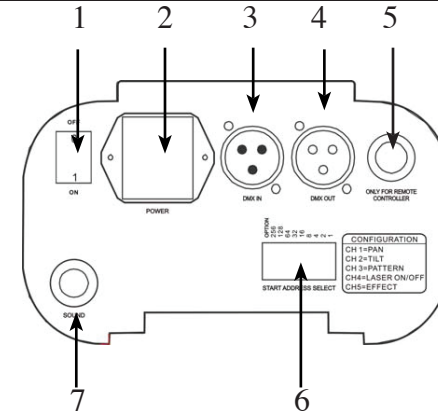

- 1. Power Switch** - This switch will control the unit's main power.
- 2. Power Cord/Breaker** - Connect only to a matching power outlet. Never use this fixture if the ground prong has been removed or broken off. A 2A built-in safety breaker to reduce the risk of electrical shock or fire and protect the circuitry. In the case of an internal short or power surge.
- 3. XLR Input Jack** - This jack is used to accept an incoming DMX signal or Master/Slave signal.
- 4. XLR Output Jack** - This jack is used to transmit the incoming DMX signal to another DMX fixture, or transmit a Master/Slave signal to the next Emerald Scan II in the chain. For best results in DMX or Master/Slave mode terminate this jack if it is the last unit in the chain. See "Terminator" on page 9.
- 5. BC 30 Controller Jack** - This jack is for use with the optional BC 30 controller only. Do not attempt to connect an audio signal to this jack, this will damage the PC board and void your manufacturer's warranty!
- 6. Dip Switches** - These switches serve two functions. In DMX mode each switch corresponds to a specific value based on binary code. See page 8 for a detailed explanation of DMX binary code.
- 7. Microphone** - This microphone receives external low frequencies to trigger the unit in Sound-Active mode. This microphone is designed to receive low frequency sounds only, tapping on the microphone and high pitch sounds may not trigger the unit.

Power Supply: Before plugging your unit in, be sure the source voltage in your area matches the required voltage for your American DJ® Emerald Scan II. The American DJ® Emerald Scan II is 120v only. Because line voltage may vary from venue to venue, you should be sure your unit voltages matches the wall outlet voltage before attempting to operate you fixture.

DMX-512: DMX is short for Digital Multiplex. This is a universal protocol used as a form of communication between intelligent fixtures and controllers. A DMX controller sends DMX data instructions from the controller to the fixture. DMX data is sent as serial data that travels from fixture to fixture via the DATA “IN” and DATA “OUT” XLR terminals located on all DMX fixtures (most controllers only have a DATA “OUT” terminal).

DMX Linking: DMX is a language allowing all makes and models of different manufactures to be linked together and operate from a single controller, as long as all fixtures and the controller are DMX compliant. *To ensure proper DMX data transmission, when using several DMX fixtures try to use the shortest cable path possible. The order in which fixtures are connected in a DMX line does not influence the DMX addressing. For example; a fixture assigned a DMX address of 1 may be placed anywhere in a DMX line, at the beginning, at the end, or anywhere in the middle. When a fixture is assigned a DMX address of 1, the DMX controller knows to send DATA assigned to address 1 to that unit, no matter where it is located in the DMX chain.*

Dipswitches in DMX mode: This unit uses dipswitches to assign a DMX address. Each dipswitch represents a binary value.

Dipswitch 1 address equals 1

Dipswitch 2 address equals 2

Dipswitch 3 address equals 4

Dipswitch 4 address equals 8

Dipswitch 5 address equals 16

Dipswitch 6 address equals 32

Dipswitch 7 address equals 64

Dipswitch 8 address equals 128

Dipswitch 9 address equals 256

Dipswitch 10 - Some units omit dipswitch 10. When a unit does include dipswitch #10, it is usually used for special functions such as

sound activation.

Assigning DMX Address: Each dipswitch has a preset value. A specific DMX address is set by combining the dipswitches that sum your desired value. For example: To achieve a DMX address of 7, combine dipswitches 1, 2, and 3. Since dipswitch 1 has a value of 1, dipswitch 2 has a value of 2, and dipswitch 3 has a value of 4, the combination of the three create a DMX value of 7. (See example below).

Set DMX address 1:

Dip-switches # 1 = 1

Set DMX address 7:

Dip-switches # 1 = 1

2 = 2

3 = 4

= 7

Data Cable (DMX Cable) Requirements (For DMX and Master/Slave Operation): The Emerald Scan II can be controlled via DMX-512 protocol. The Emerald Scan II is a five channel DMX unit. The DMX address is set on the side panel of the Emerald Scan II. Your unit and your DMX controller require a standard 3-pin XLR connector for data input and data output (Figure 1). If you are making your own cables, be sure to use standard two conductor shielded cable (This cable may be purchased at almost all pro sound and lighting stores). Your cables should be made with a male and female XLR connector on either end of the cable. Also remember that DMX cable must be daisy chained and can not be split.

Notice: Be sure to follow figures two and three when making your own cables. Do not use the ground lug on the XLR connector. Do not connect the cable’s shield conductor to the ground lug or allow the shield conductor to come in contact with the XLR’s outer casing. Grounding the shield could cause a short circuit and erratic behavior.

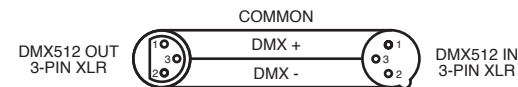

Figure 2

Emerald Scan II

Set Up

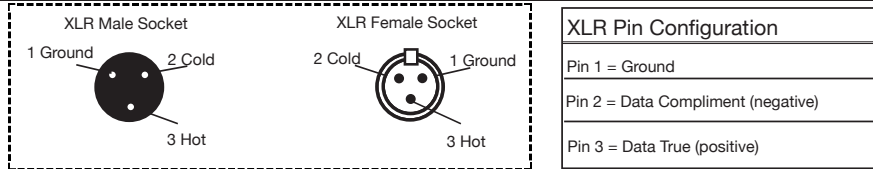

Figure 3

Special Note: Line Termination. When longer runs of cable are used, you may need to use a terminator on the last unit to avoid erratic behavior. A terminator is a 90-120 ohm 1/4 watt resistor which is connected between pins 2 and 3 of a male XLR connector (DATA + and DATA -). This unit is inserted in the female XLR socket of the last unit in your daisy chain to terminate the line. Using a cable terminator (ADJ part number Z-DMX/T) will decrease the possibilities of erratic behavior.



Termination reduces signal errors and avoids signal transmission problems and interference. It is always advisable to connect a DMX terminal, (Resistance 120 Ohm 1/4 W) between PIN 2 (DMX-) and PIN 3 (DMX+) of the last fixture.

Figure 4

5-Pin XLR DMX Connectors. Some manufactures use 5-pin XLR connectors for DATA transmission in place of 3-pin. 5-pin XLR fixtures may be implemented in a 3-pin XLR DMX line. When inserting standard 5-pin XLR connectors in to a 3-pin line a cable adaptor must be used, these adaptors are readily available at most electric stores. The chart below details a proper cable conversion.

3-Pin XLR to 5-Pin XLR Conversion		
Conductor	3-Pin XLR Female (Out)	5-Pin XLR Male (In)
Ground/Shield	Pin 1	Pin 1
Data Compliment (- signal)	Pin 2	Pin 2
Data True (+ signal)	Pin 3	Pin 3
Not Used		Pin 4 - Do Not Use
Not Used		Pin 5 - Do Not Use

Emerald Scan II

Operation

CAUTION IMPORTANT! When installing this projector, make sure that it is mounted in a manner that prevents the audience from looking directly into the beam, and the beam from striking the audience.

General Operation: This fixture is designed to operate as a stand alone, sound-active unit, or in a Master/Slave configuration. It can also operate via DMX controller. The Emerald Scan II is ready to be plugged in out of the box. After plugging the power cord into a power outlet, flip the power switch to.

Note: Dipswitch #10 in the “On” position will invert the pan and tilt function. This function is mainly used when using two or more fixtures.

Operating Modes:

Universal DMX Control: This mode allows you to use a universal DMX-512 controller such as the American DJ® DMX Operator™ or Show Designer.™

- To control your fixture in DMX mode, follow the set-up procedures on pages 9-11 as well as the set-up procedures included with your DMX controller.
- For longer cable runs (more than a 100 feet) use a terminator on the last fixture.
- The Emerald Scan II uses five DMX channels. See page 14 for detailed description of the DMX traits. Use your DMX controller to activate the various built-in patterns.
- For help operating in DMX mode consult the manual included with your DMX controller.

Stand-Alone Operation (Sound Active): This mode allows a single unit to run to the beat of the music. Only use this mode when running a single unit, or when running several units as individuals.

- Set dipswitch #1 to the “ON” position to activate Stand-Alone.
- The unit will react to the low frequencies of music via the internal microphone.
- The optional *BC 30 Controller* (not included) may be used with this mode to control different functions including blackout.

Master-Slave Operation (Sound Active): This mode will allow

Emerald Scan II

Operation

you to link up to 16 units together and operate without a controller. In Master-Slave mode, the units will react to sound. In Master-Slave operation one unit will act as the controlling unit and the others will react to the controlling units programs. Any unit can act as a Master or as a Slave.

1. Using standard XLR microphone cables, daisy chain your units together via the XLR connector on the rear of the units. Remember the Male XLR connector is the input and the Female XLR connector is the output. For longer cable runs we suggest a terminator at the last fixture.
2. Choose a unit to function as the Master and set dipswitch #1 to the "On" position.. This unit must be the first unit in line. Then simply daisy chain the units together using XLR cables.
3. Now set the Slave units dipswitches to whatever you desire, but dipswitch #1 must be in the "Off" position. Now they should react the same as the MASTER.
4. The optional *BC 30 Controller* (not included) may be used to control different functions including blackout.

Emerald Scan II

Optional BC 30 Controls

Note: BC 30 controller sold separately

Stand By	Blackout the unit		
Function	Dot on line or discontinuous line effect	Select pattern (8 patterns)	select pan/tilt movement (12 movements)
Mode	Sound (LED off)	Movement (LED on)	Pattern (LED blinking)





















Emerald Scan II

Fuse Replacement

Fuse Replacement: Locate and remove the unit's power cord. Once the cord has been removed located the fuse holder located inside the power socket. Insert a flat-head screw driver into the power socket and gently pry out the fuse holder. Remove the bad fuse and replace with a new one. The fuse holder has a built-in socket for a spare fuse be sure not to confuse the spare fuse with active fuse.

Emerald Scan II

DMX Traits

CHANNEL 1	CHANNEL 2	CHANNEL 3	CHANNEL 4	CHANNEL 5
PAN	TILT	Pattern	Laser on/off	Effect
		240-255 	239-255 Laser on	 3D Effect
		224-239 	184-211 -----	
		208-223 	156-183 -----	
		192-207 	128-155 -----	
		176-191 	100-127 -----	
		160-175 	072-099 -----	
		144-159 	044-071 ----	
		128-143 	016-043 ---	
		112-127 	000-015 Laser off	
		096-111 		
		080-095 		
		064-079 		
		048-063 		
		032-047 		
		016-031 		
		000-015 		

Emerald Scan II

Cleaning

Fixture Cleaning: Due to fog residue, smoke, and dust cleaning the internal and external lenses should be carried out periodically to optimize light output.

1. Use normal glass cleaner and a soft cloth to wipe down the outside casing.
2. Clean the external optics with glass cleaner and a soft cloth every 20 days.
3. Always be sure to dry all parts completely before plugging the unit back in.

Cleaning frequency depends on the environment in which the fixture operates (I.e. smoke, fog residue, dust, dew). In heavy use we recommend cleaning on a monthly basis. Periodic cleaning will ensure longevity, and crisp beam output.

Emerald Scan II

Warranty

MANUFACTURER'S LIMITED WARRANTY

A. American DJ, Inc. hereby warrants, to the original purchaser, American DJ and American Audio products to be free of manufacturing defects in material and workmanship for a prescribed period from the date of purchase (see specific warranty period on reverse). This warranty shall be valid only if the product is purchased within the United States of America, including possessions and territories. It is the owner's responsibility to establish the date and place of purchase by acceptable evidence, at the time service is sought.

B. For warranty service you must obtain a Return Authorization number (RA#) before sending back the product. Contact American DJ, Inc. Service Department at 800-322-6337. Send the product only to the American DJ, Inc. factory. All shipping charges must be pre-paid. If the requested repairs or service (including parts replacement) are within the terms of this warranty, American DJ, Inc. will pay return shipping charges only to a designated point within the United States. If the entire instrument is sent, it must be shipped in its original package. No accessories should be shipped with the product. If any accessories are shipped with the product, American DJ, Inc. shall have no liability whatsoever for loss of or damage to any such accessories, nor for the safe return thereof.

C. This warranty is void if the serial number has been altered or removed; if the product is modified in any manner which American DJ, Inc. concludes, after inspection, affects the reliability of the product; if the product has been repaired or serviced by anyone other than the American DJ, Inc. factory unless prior written authorization was issued to purchaser by American DJ, Inc.; if the product is damaged because not properly maintained as set forth in the instruction manual.

D. This is not a service contract, and this warranty does not include maintenance, cleaning or periodic check-up. During the period specified above, American DJ, Inc. will replace defective parts at its expense with new or refurbished parts, and will absorb all expenses for warranty service and repair labor by reason of defects in material or workmanship. The sole responsibility of American DJ, Inc. under this warranty shall be limited to the repair of the product, or replacement thereof, including parts, at the sole discretion of American DJ. All products covered by this warranty were manufactured after January 1, 1990, and bear identifying marks to that effect.

E. American DJ, Inc. reserves the right to make changes in design and/or improvements upon its products without any obligation to include these changes in any products theretofore manufactured. No warranty, whether expressed or implied, is given or made with respect to any accessory supplied with products described above. Except to the extent prohibited by applicable law, all implied warranties made by American DJ, Inc. in connection with this product, including warranties of merchantability or fitness, are limited in duration to the warranty period set forth above. And no warranties, whether expressed or implied, including warranties of merchantability or fitness, shall apply to this product after said period has expired. The consumer's and/or Dealer's sole remedy shall be such repair or replacement as is expressly provided above; and under no circumstances shall American DJ, Inc. be liable for any loss or damage, direct or consequential, arising out of the use of, or inability to use, this product.

This warranty is the only written warranty applicable to American DJ and American Audio Products and supersedes all prior warranties and written descriptions of warranty terms and conditions heretofore published.

MANUFACTURER'S LIMITED WARRANTY PERIODS:

- All American Audio Products = 1-year (365 day) Limited Warranty (except V-Plus Series Amplifiers)
- All American Audio V-Plus Series Amplifiers = 3-year (1095 day) Limited Warranty
- American DJ Lighting and American DJ Branded Products = 1-year (365 day) Limited Warranty (Such as: Special Effect Lighting, Intelligent Lighting, UV lighting, Strobos, Fog Machines, Bubble Machines, Mirror Balls, Par Cans, Trussing, Lighting Stands etc. excluding Laser Products, lamps, and Star Tec Series)
- American DJ Laser Products and Star Tec Products = 90-Day Limited Warranty
- American DJ L.E.D. Products = 3-year (1095 day) Limited Warranty (excluding motors which have a 1-year (365 day Limited Warranty)

©American DJ® - www.americandj.com - Emerald Scan II Instruction Manual Page 15

Emerald Scan II

Specifications

Model: Emerald Scan II

Voltage*:	120v~60Hz / 230v~50Hz
Lasers:	4.9mW Green Diode
Fuse:	4A
Dimensions:	5.5" (L) x 8" (W) x 16" (H)
Weight:	6 Lbs. (3kg)
Duty Cycle:	None
Ventilation:	Fan Cooled
Warranty:	90 Days

**Voltage is preset at the factory and can not be changed by the user.*

Please Note: Specifications and improvements in the design of this unit and this manual are subject to change without any prior written notice.

American DJ®

American DJ World Headquarters:

6122 S. Eastern Ave. Los Angeles, CA 90040 USA

Tel: 323-582-2650 / Fax: 323-725-6100

Web: www.americandj.com / E-mail: info@americandj.com