

J-SIX™



Snapshot

Use on Dimmer	⊘
Outdoor Use	⊘
Sound Activated	✓
DMX	⊘
Master/Slave	⊘
120 V / 230 V Switchable	✓
Replaceable Fuse	✓
User Serviceable	⊘
Duty Cycle	⊘

User Manual

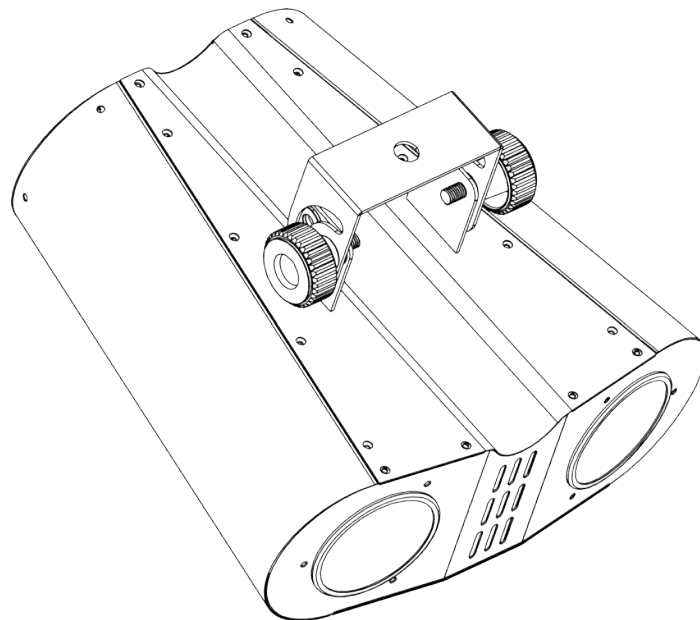
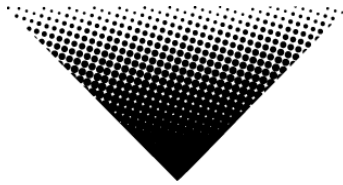

TABLE OF CONTENTS

1. BEFORE YOU BEGIN	2
WHAT IS INCLUDED.....	2
UNPACKING INSTRUCTIONS.....	2
MANUAL CONVENTIONS.....	2
ICONS.....	3
AC POWER.....	3
<i>Power Linking</i>	3
CONTACT US.....	4
SAFETY INSTRUCTIONS.....	4
2. INTRODUCTION	5
FEATURES.....	5
PRODUCT OVERVIEW.....	5
MOUNTING.....	6
<i>Orientation</i>	6
<i>Rigging</i>	6
<i>Fuse Replacement</i>	6
3. OPERATING INSTRUCTIONS	6
STANDALONE MODE (SOUND-ACTIVE):.....	6
4. APPENDIX	7
GENERAL MAINTENANCE.....	7
RETURNS PROCEDURE.....	7
CLAIMS.....	7
GENERAL TROUBLESHOOTING.....	8
TECHNICAL SPECIFICATIONS.....	8

1. BEFORE YOU BEGIN

What is Included

- 1 x J-Six™
- 1 x Power Cable
- 1 x Warranty Card
- 1 x User Manual

Unpacking Instructions

Immediately upon receiving a fixture, carefully unpack the carton, check the contents to ensure that all parts are present, and have been received in good condition. Notify the shipper immediately and retain packing material for inspection if any parts appear damaged from shipping or the carton itself shows signs of mishandling. Save the carton and all packing materials. In the event that a fixture must be returned to the factory, it is important that the fixture be returned in the original factory box and packing.

Manual Conventions



CHAUVET® manuals use the following conventions to differentiate certain types of information from the regular text.

CONVENTION	MEANING
[10]	A DIP switch to be configured
<Menu>	A key to be pressed on the fixture's control panel
1~512	A range of values
50/60	A set of values of which only one can be chosen
Settings	A menu option not to be modified (for example, showing the operating mode/current status)

MENU > Settings	A sequence of menu options to be followed
ON	A value to be entered or selected

Icons

This manual uses the following icons to indicate information that requires special attention on the part of the user.

ICON	MEANING
	This paragraph contains critical installation, configuration or operation information. Failure to comply with this information may render the fixture partially or completely inoperative, cause damage to the fixture or cause harm to the user.
	This paragraph contains important installation or configuration information. Failure to comply with this information may prevent the fixture from functioning correctly.
	This paragraph reminds you of useful, although not critical, information.

AC Power

This fixture has power switch that can accommodate 120 V and 230 V, 50/60 Hz. The only thing necessary to do before powering on the unit is to make sure the power switch is set to the appropriate line voltage. All fixtures must be powered directly off a switched circuit and cannot be run off a rheostat (variable resistor) or dimmer circuit, even if the rheostat or dimmer channel is used solely for a 0% to 100% switch.



All fixtures must be connected to circuits with a suitable Earth Ground.

Power Linking

This fixture contains power linking via the edison outlet located next to the power input cable. Please see the diagram below for further explanation.



The maximum quantity of fixtures that may be linked is 36.

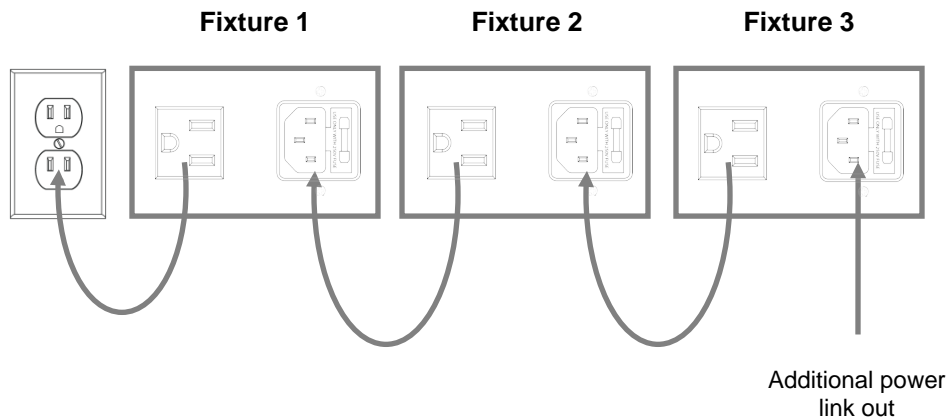

Contact Us

World Wide

General Information CHAUVET®
5200 NW 108th Avenue
Sunrise, FL 33351
voice: 954.929.1115
fax: 954.929.5560
toll free: 800.762.1084

Technical Support CHAUVET®
5200 NW 108th Avenue
Sunrise, FL 33351
voice: 954.929.1115 **(Press 4)**
fax: 954.929.5560 **(Attention: Service)**

World Wide Web www.chauvetlighting.com

Safety Instructions



Please read these instructions carefully, which includes important information about the installation, usage and maintenance of this product.

- Please keep this User Manual for future consultation. If you sell the unit to another user, be sure that they also receive this instruction booklet.
- Always make sure that you are connecting to the proper voltage, and that the line voltage you are connecting to is not higher than that stated on the decal or rear panel of the fixture.
- This product is intended for indoor use only! To prevent risk of fire or shock, do not expose fixture to rain or moisture.
- Make sure there are no flammable materials close to the unit while operating.
- The unit must be installed in a location with adequate ventilation, at least 20 in (50 cm) from adjacent surfaces. Be sure that no ventilation slots are blocked.
- Secure fixture to fastening device using a safety chain.
- Maximum ambient temperature (Ta) is 104° F (40° C). Do not operate fixture at temperatures higher than this.
- In the event of a serious operating problem, stop using the unit immediately. Never try to repair the unit by yourself. Repairs carried out by unskilled people can lead to damage or malfunction. Please contact the nearest authorized technical assistance center.
- Never connect the device to a dimmer pack.
- Make sure the power cord is never crimped or damaged.
- Never disconnect the power cord by pulling or tugging on the cord.
- Avoid direct eye exposure to the light source while it is on.



There are no user --serviceable parts inside the unit. Do not open the housing or attempt any repairs yourself. In the unlikely event your unit may require service, please contact CHAUVET® at: 954-929-1115.

2. INTRODUCTION

Features

- Dual LED moonflower effect
- Two LED pods rotate separately, together and/or against each other
- Built-in sound activated programs
- Additional power output: max 36 units

Product Overview

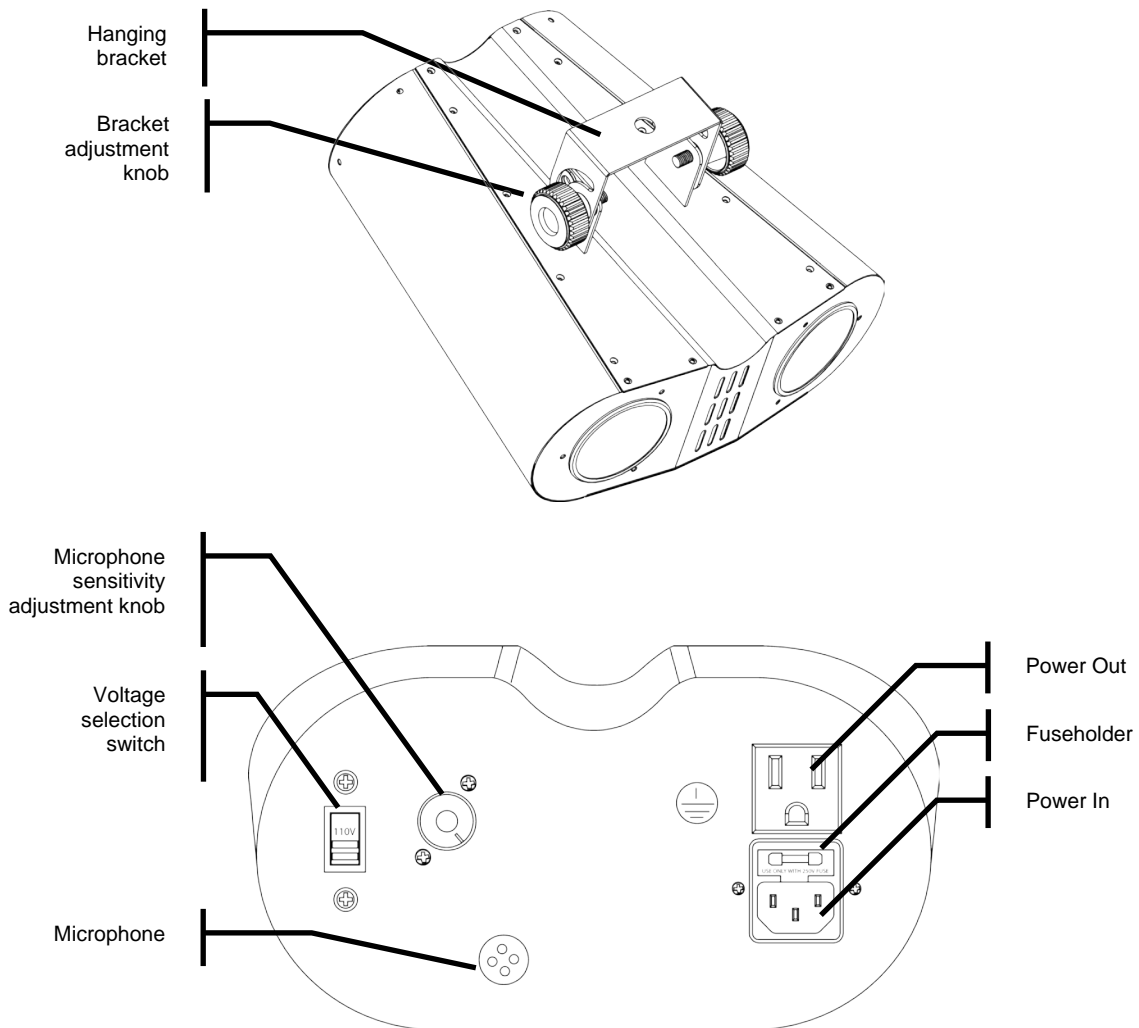

Mounting

Orientation

This fixture may be mounted in any safe position, provided there is adequate room for ventilation.

Rigging

It is important never to obstruct the fan or vents pathway. Mount the fixture using, a suitable “C” or “O” type clamp. Adjust the angle of the fixture by loosening both knobs and tilting the fixture. After finding the desired position, retighten both knobs.

- When selecting installation location, take into consideration lamp replacement access and routine maintenance.
- Safety cables must always be used.
- Never mount in places where the fixture will be exposed to rain, high humidity, extreme temperature changes or restricted ventilation.

Hanging Clamp

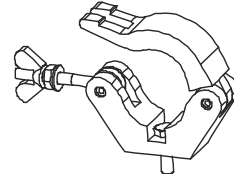

Note!
Clamp is sold separately.



Disconnect the power cord before replacing a fuse and always replace with the same type fuse.



Fuse Replacement

1. With a flat head screwdriver wedge the fuse holder out of its housing.
2. Remove the damaged fuse from its holder and replace with exact same type fuse.
3. Insert the fuse holder back in its place and reconnect power.

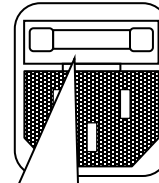

The fuse is located inside this compartment. Remove using a flat head screwdriver.

3. OPERATING INSTRUCTIONS

Standalone Mode (Sound-Active):

This mode allows a single unit to run to the beat of the music

- 1) Plug the unit into power, using the provided power cable.
- 2) The unit will react to the low frequencies of music via the internal microphone in Sound Active mode.
- 3) Use the audio sensitivity knob on the back of the unit to make the unit more or less sensitive in Sound-Active mode. Turning the knob counterclockwise decreases the sensitivity; turning the knob clockwise increases the sensitivity.

4. APPENDIX

General Maintenance

To maintain optimum performance and minimize wear fixtures should be cleaned frequently. Usage and environment are contributing factors in determining frequency. As a general rule, fixtures should be cleaned at least twice a month. Dust build up reduces light output performance and can cause overheating. This can lead to reduced lamp life and increased mechanical wear. Be sure to power off fixture before conducting maintenance.

Unplug fixture from power. Use a vacuum or air compressor and a soft brush to remove dust collected on external vents and internal components. Clean all glass when the fixture is cold with a mild solution of glass cleaner or Isopropyl Alcohol and a soft lint free cotton cloth or lens tissue. Apply solution to the cloth or tissue and drag dirt and grime to the outside of the lens. Gently polish optical surfaces until they are free of haze and lint.

The cleaning of internal and external optical lenses and/or mirrors must be carried out periodically to optimize light output. Cleaning frequency depends on the environment in which the fixture operates: damp, smoky or particularly dirty surrounding can cause greater accumulation of dirt on the unit's optics. Clean with soft cloth using normal glass cleaning fluid. Always dry the parts carefully. Clean the external optics at least every 20 days. Clean the internal optics at least every 30/60 days.

Returns Procedure

Returned merchandise must be sent prepaid and in the original packing, call tags will not be issued. Package must be clearly labeled with a Return Merchandise Authorization Number (RMA #). Products returned without an RMA # will be refused. Call CHAUVET® and request RMA # prior to shipping the fixture. Be prepared to provide the model number, serial number and a brief description of the cause for the return. Be sure to properly pack fixture, any shipping damage resulting from inadequate packaging is the customer's responsibility. CHAUVET® reserves the right to use its own discretion to repair or replace product(s). As a suggestion, proper UPS packing or double-boxing is always a safe method to use.



If you are given an RMA #, please include the following information on a piece of paper inside the box:

- 1) Your name
- 2) Your address
- 3) Your phone number
- 4) The RMA #
- 5) A brief description of the symptoms

Claims

Damage incurred in shipping is the responsibility of the shipper; therefore the damage must be reported to the carrier upon receipt of merchandise. It is the customer's responsibility to notify and submit claims with the shipper in the event that a fixture is damaged due to shipping. Any other claim for items such as missing component/part, damage not related to shipping, and concealed damage, must be made within seven (7) days of receiving merchandise.

General Troubleshooting

Symptom	Solution(s)	Applies to			
		Lights	Foggers & Snow	Controllers	Dimmers & Chaser
Breaker/Fuse keeps blowing	Check total load placed on device				✓
Device has no power	Check for power on Mains. Check device's fuse. (internal and/or external)	✓		✓	✓
No light output	Call service technician	✓			



If you still have a problem after trying the above solutions, please contact CHAUVET® Technical Support.

Technical Specifications

WEIGHT & DIMENSIONS

Length.....	11.3 in (287 mm)
Width.....	11.1 in (281 mm)
Height.....	7.2 in (182 mm)
Weight.....	6.9 lbs (3.2 kg)

POWER

Manual Power Switch.....	100 V / 230 VAC, 50/60 Hz
Power Consumption @ 120 V.....	16 W, 0.2 A max, 0.2 A inrush
Power Consumption @ 230 V.....	15 W, 0.1 A max, 0.2 A inrush
Fuse.....	F 1 A, 250 V

LIGHT SOURCE

LED (per pod).....	56 x (16 red, 24 green, 16 blue) 100,000 hrs (112 total)
--------------------	--

PHOTO OPTIC

Coverage Angle.....	63°
---------------------	-----

THERMAL

Maximum ambient temperature.....	104° F (40° C)
----------------------------------	----------------

ORDERING INFORMATION

J-Six™.....	JSIX
-------------	------

WARRANTY INFORMATION

Warranty.....	1-year limited warranty
---------------	-------------------------

CHAUVET®, 2012, All Rights Reserved

Information and specifications in this User Manual are subject to change without notice. CHAUVET® assumes no responsibility or liability for any errors or inaccuracies that may appear in this manual.