

# COLORmist™ System

## **MIST-PAR80**

COLORmist™ (Par)

## **MIST-PANEL**

COLORmist™ Panel

## **MIST-CON**

COLORmist™ Controller

## **MIST-PS8**

COLORmist™ Power Unit

## USER MANUAL

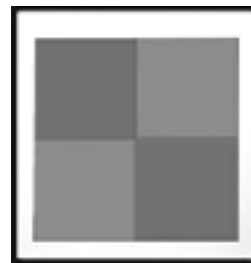

CHAUVET, 3000 N 29<sup>th</sup> Ct, Hollywood, FL 33020 U.S.A  
(800) 762-1084 – (954) 929-1115  
FAX (954) 929-5560  
[www.chauvetlighting.com](http://www.chauvetlighting.com)

# Table of Content

<b>BEFORE YOU BEGIN.....</b>	<b>3</b>
COLORMIST™ SYSTEM.....	3
UNPACKING INSTRUCTIONS.....	3
AC POWER .....	3
SAFETY INSTRUCTIONS.....	3
<b>INTRODUCTION .....</b>	<b>4</b>
FEATURES.....	4
MIST-CON DMX CHANNEL SUMMARY .....	4
PRODUCT OVERVIEW.....	5
<b>SETUP .....</b>	<b>6</b>
POWER .....	6
MOUNTING (MIST-PAR80).....	6
MOUNTING (MIST-PAN).....	6
<b>OPERATING INSTRUCTIONS .....</b>	<b>7</b>
CONTROL PANEL .....	7
MENU DIAGRAM.....	7
SYSTEM SETUP .....	7
Initial Setup.....	7
Re-initialization .....	7
SINGLE ACTION PROGRAMS.....	8
Choosing Single Action Programs .....	8
DMX CONTROL MODE.....	9
Setting the DMX address .....	9
Running in DMX Mode .....	9
Daisy Chain Connection.....	9
SYSTEM CONFIGURATION & CONNECTION.....	9
<b>APPENDIX .....</b>	<b>10</b>
DMX PRIMER .....	10
Fixture Linking .....	10
DMX CHANNEL VALUES .....	11
MIST-PS8 (POWER UNIT) CONFIGURATIONS .....	12
RETURNS PROCEDURE .....	12
CLAIMS .....	12
TECHNICAL SPECIFICATIONS.....	13
TECHNICAL SUPPORT .....	13

# BEFORE YOU BEGIN

## COLORmist™ System

Your COLORmist™ LED color system may include either of the two packages listed;

### SYS-PAR4, PAR Pack System

1 x MIST-CON, Controller  
4 x MIST-PAR80, Par Can  
1 x MIST-PS8, Power Unit  
1 x MIST-CBL33, Power/Signal Cable 33'  
4 x MIST-CBL5, Power/Signal Cable 5'  
User Manual & Warranty Card

### SYS-PANEL2, Panel Pack System

1 x MIST-CON, Controller  
2 x MIST-PANEL, Panel  
1 x MIST-PS8, Power Unit  
1 x MIST-CBL33, Power/Signal Cable 33'  
2 x MIST-CBL5, Power/Signal Cable 5'  
User Manual & Warranty Card

## Unpacking Instructions

Immediately upon receiving a product, carefully unpack the carton, check the contents to ensure that all parts are present, and have been received in good condition. Notify the shipper immediately and retain packing material for inspection if any parts appear damaged from shipping or the carton itself shows signs of mishandling. Save the carton and all packing materials. In the event that a fixture must be returned to the factory, it is important that the fixture be returned in the original factory box and packing.

## AC Power

To determine the power requirements for a particular product, see the label affixed to the back plate of the product or refer to the product's specifications chart. A product's listed current rating is its average current draw under normal conditions. All fixtures must be powered directly off a switched circuit and cannot be run off a rheostat (variable resistor) or dimmer circuit, even if the rheostat or dimmer channel is used solely for a 0% to 100% switch. Before applying power, check that the source voltage matches the product's requirement. Check the product or device carefully to make sure that if a voltage selection switch exists that it is set to the correct line voltage you will use.

MIST-PS8 AC Voltage Switch



### Warning!

***If applicable, verify that the power select switch on your unit matches the line voltage applied. All fixtures must be connected to circuits with a suitable Earth Ground.***

## Safety Instructions



Please read these instructions carefully, which includes important information about the installation, usage and maintenance?



- Please keep this User Guide for future consultation. If you sell the unit to another user, be sure that they also receive this instruction booklet.
- Always make sure that you are connecting to the proper voltage and that the line voltage you are connecting to is not higher than that stated on decal or rear panel of the fixture.
- This product is intended for indoor use only!
- To prevent risk of fire or shock, do not expose fixture to rain or moisture. Make sure there are no flammable materials close to the unit while operating.
- The unit must be installed in a location with adequate ventilation, at least 50cm from adjacent surfaces. Be sure that no ventilation slots are blocked.
- Always disconnect from power source before servicing or replacing lamp or fuse and be sure to replace with same lamp source.
- Maximum ambient temperature is Ta: 40°. Do not operate fixture at temperatures higher than this.
- In the event of serious operating problem, stop using the unit immediately. Never try to repair the unit by yourself. Repairs carried out by unskilled people can lead to damage or malfunction. Please contact the nearest authorized technical assistance center. Always use the same type spare parts.
- Don't connect the device to a dimmer pack.
- Make sure power cord is never crimped or damaged.
- Never disconnect power cord by pulling or tugging on the cord.

### Caution!

***There are no user serviceable parts inside the unit. Do not open the housing or attempt any repairs yourself. In the unlikely event your unit may require service, please contact CHAUVET.***

# INTRODUCTION

## Features

### COLORMist™ (MIST-PAR80)

- 80 LEDs per surface
  - Red (27), Green (27) and Blue (26)
- Ultra bright LED's
- Stand alone color change programs using (COLORMist™ Power unit)
- 7 static colors, 13 color pattern chase programs with adjustable speeds, auto run, sound active mode and RGB Mix via (MIST-CON COLORMist™ Controller)
- Low power consumption and heat generation
- No infra-red or UV emissions
- Up to 100,000-hour LED life span
- Master/Slave mode (requires COLORMist™ Power unit)
- MIST-PAR80 and MIST-PANEL require the COLORMist™ Power unit for operation
- Also links with COLORMist™ Panel

### COLORMist™ Panel (MIST-PANEL)

- 72 LEDs per Panel, distributed into 4 square sections with 18 LEDs each
  - Red (24), Green (24) and Blue (24)
- Ultra bright LED's
- Stand alone color change programs using (COLORMist™ Power unit)
- 7 static colors, 13 color pattern chase programs with adjustable speeds, auto run, sound active mode and RGB Mix via (MIST-CON COLORMist™ Controller)
- Low power consumption and heat generation
- No infra-red or UV emissions
- Up to 100,000-hour LED life span
- Master/Slave mode (requires COLORMist™ Power unit)
- MIST-PAR80 and MIST-PANEL require the COLORMist™ Power unit for operation
- Also links with COLORMist™

### COLORMist™ Controller (MIST-CON)

#### CONTROL FEATURES

- 4 channel DMX controlled (controller device)
- 7 independently selectable preset colors, 13 programmed chases adjustable in speed or flash rate, Auto mode, Sound Active and RGB Mix control mode
- Select quantity of fixtures
- Speed, Flash or Chase control channel

#### FEATURES

- Built in Microphone
- Digital LCD display

## MIST-CON DMX Channel Summary

CHANNEL	FUNCTION
1	Program mode
2	Red / Run Speed
3	Green / Flash Speed
4	Blue / Select Color

## Product Overview

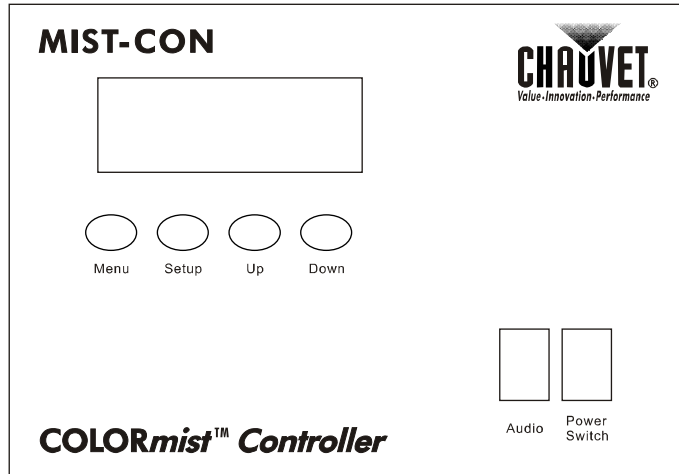

### SEGMENT BUTTONS

BUTTONS	
<b>Menu</b>	Returns to Main Menu
<b>Setup</b>	Enter menu selection
<b>Up</b>	Steps backward through menu functions
<b>Down</b>	Steps forward through menu functions
<b>Audio</b>	Enables Sound Activation
<b>Power Switch</b>	Turns on controller

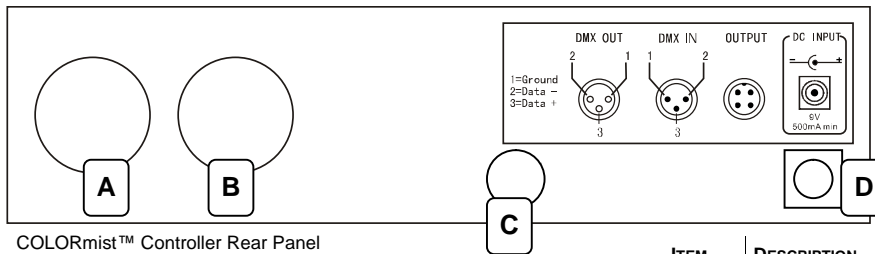

COLORmist™ Controller Rear Panel

ITEM	DESCRIPTION
<b>A</b>	3-Pin female XLR DMX output connector
<b>B</b>	3-Pin male XLR DMX input connector
<b>C</b>	Power and Signal output
<b>D</b>	DC input, External Power Supply



COLORmist™

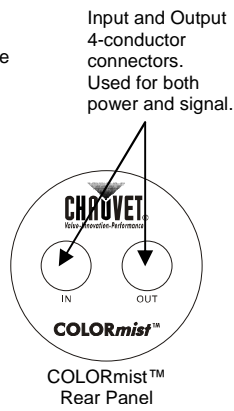

COLORmist™ Rear Panel

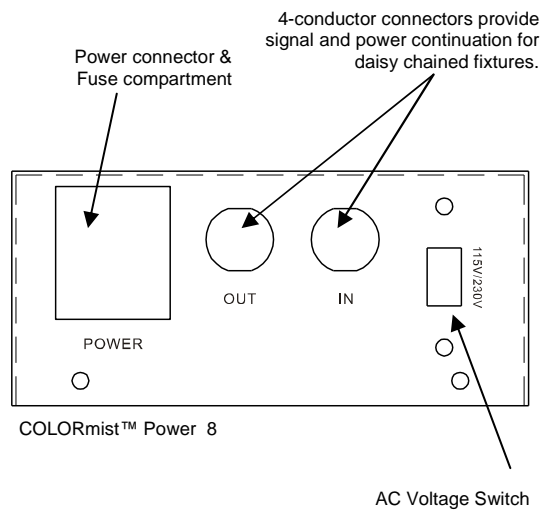

COLORmist™ Power 8

AC Voltage Switch

### NOTICE

Both COLORmist™ fixtures are powered using the MIST-PS8 Power Unit and require it for operation.

Please refer to page 8 for setup configuration options.



COLORmist™ Power 8

# SETUP

## Power

### **Warning!**

**Verify that the power indicator label on your unit matches the line voltage applied. All fixtures must be connected to circuits with a suitable Earth Ground.**

- To determine the power requirements for a particular fixture, see the label affixed to the back plate of the fixture or refer to the fixture's specifications chart.
- A fixture's listed current rating is its average current draw under normal conditions.
- All fixtures must be powered directly off a switched circuit and cannot be run off a rheostat (variable resistor) or dimmer circuit, even if the rheostat or dimmer channel is used solely for a 0% to 100% switch.
- Before applying power to a fixture, check that the source voltage matches the fixture's requirement.
- All fixtures must be connected to circuits with a suitable Earth Ground.

### Power Cable Configuration

CABLE	PIN	INTERNATIONAL
BROWN	Live	L
BLUE	Neutral	N
YELLOW/GREEN	Earth	EG (Ground)

## Mounting (MIST-PAR80)

### Orientation

This fixture can be mounted on a truss using a clamp in any position or on a strut system for track style lighting.

Hanging Clamp



### Rigging

The fixture includes a mounting yoke to which 1 rigging clamp can be bolted.

1. Align the clamp screw with the center hole on the yoke and tighten.
2. Verify the structure can hold 10 times the weight of all to-be installed fixtures.
3. Adjust the angle on the yoke arm as necessary.

## Mounting (MIST-PAN)

The COLORmist™ Panel can be surface mounted directly using its fastening hinge located directly behind the unit or utilizing the surface mounting bracket especially made to fit. The bracket can be surface mounted first then later the panel can be mounted onto the bracket.

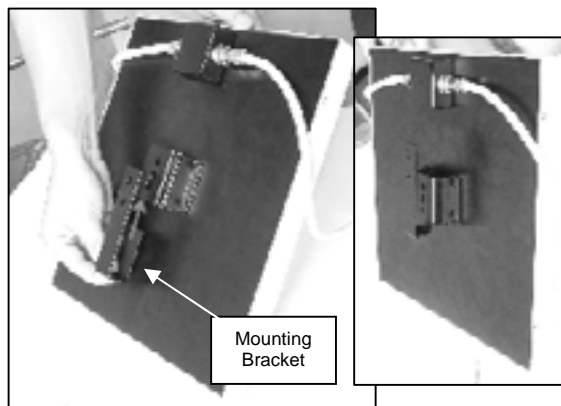

# OPERATING INSTRUCTIONS

## Control Panel

On the control panel you can set the controller for single action mode where preset programs are run either statically, automatically or by sound-activation or assign a starting DMX channel address.

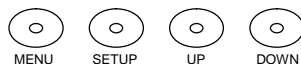

**[MENU]** Returns to Main menu or step backward through functions

**[SET UP]** Enters menu selection

**[UP]** Steps backward through menu selection

**[DOWN]** Steps forward through menu selection

## Menu Diagram

### System Setup

You will need to let the controller be aware of the number of par cans and/or panels connected in series. This is essential in order for the chase and flow programs to perform correctly through out the entire stretch of fixtures.

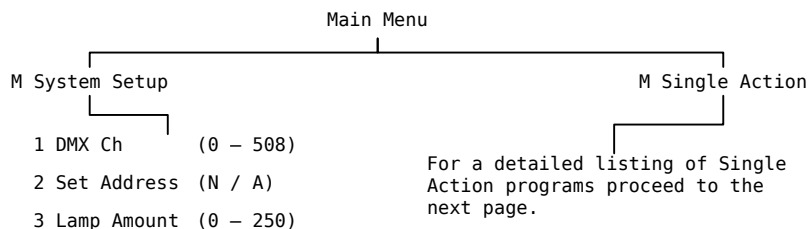

### Initial Setup

1. Press the **MODE** button until the display shows “M System Setup”.
2. Press the **SETUP** button then the **UP** button once. It will show “3 Lamp Amount”.
3. Press the **SETUP** button to enter the function. A number will now appear to the right of the text as shown here in an example. “3 Lamp Amount 34”.
4. Use the **UP** and **DOWN** buttons to locate a number between 0 and 250. This represents the number of fixtures connected.
5. Press the **MODE** button to set this function.

### Re-initialization

Whenever a fixture is removed, replaced or exchanged please follow the following instructions.

1. Press the **MODE** button until the display shows “M System Setup”.
2. Press the **SETUP** button then the **UP** button twice. It will show “2 Set Address”.
3. Press the **SETUP** button to re-initialize.
4. Proceed to prior instruction “Initial Setup” and re-do.

## Single Action Programs

Single Action programs are pre-built chase and flow patterns. They can be executed either manually or by DMX control. Depending on the program the following attributes can be modified; Run Speed, Flash Frequency and Color Selection.

NUMBER	PROGRAM	TYPE	MODIFICATIONS (MODIFIER)
1	Black	Static	None
2	Red	Static	None
3	Green	Static	None
4	Blue	Static	None
5	Yellow	Static	None
6	Purple	Static	None
7	Cyan	Static	None
8	White	Static	None
9	Color Change	Auto	Run Speed, Flash Speed
10	Slow Flow 1	Auto	Run Speed, Flash Speed
11	Slow Flow 2	Auto	Run Speed, Flash Speed
12	Roll Chase 1	Auto	Run Speed, Flash Speed
13	Roll Chase 2	Auto	Run Speed, Flash Speed
14	Multi Color	Auto	Run Speed, Flash Speed
15	Fast Flow 1	Auto	Run Speed, Flash Speed
16	Fast Flow 2	Auto	Run Speed, Flash Speed
17	Fast Flow 3	Auto	Run Speed, Select Color Combination (1)
18	Fast Flow 4	Auto	Run Speed, Select Color Combination (1)
19	2 Color Chase	Auto	Run Speed, Flash Speed, Select Color Combination (1)
20	2 Color Flow	Auto	Run Speed, Flash Speed, Select Color Combination (1)
21	Any Color	-	RGB Color Mix, Red, Green, Blue
22	Color Fade	Auto	Run Speed
23	Auto Run	Auto	Run Speed, (runs all built in programs)

(1) Refer to “DMX Channel Values” for Color Combinations Table.

### Choosing Single Action Programs

1. Press the **MODE** button until the display shows “M System Setup”.
2. Press the **UP** button to arrive at “M Single Action”.
3. Press the **SETUP** button to enter menu function.
4. Press the **UP** and **DOWN** buttons to toggle built in programs. Press **SETUP** button to choose the presently viewed program number.
5. Upon selecting the program, the menu will immediately display whatever modifier may exist for that individual program selected. It can display “Flash Speed: 100” or “Run Speed: 100” for example. Pressing the **SETUP** button will toggle the various modifiers available for the program as listed in the table above.
6. Use the **UP** and **DOWN** buttons to adjust the values of modifiers accordingly. Remember that **SETUP** will toggle the various options while **UP** and **DOWN** changes the values.
7. Press the **MENU** button to retain the new settings..
8. Press **MENU** again if necessary to return to the Main Menu.



## DMX Control Mode

With exception to the system setup process all control functions on the controller can be accessed and executed externally via a Universal DMX controller. First you must connect the LED-CHVA controller to an existing DMX daisy chain. The controller is addressable just like any other DMX device or fixture and it will be controlled as if it were a fixture in most intelligent light consoles.

### Setting the DMX address

1. Press the **MODE** button until the display shows "M System Setup".
2. Press the **SETUP** button to enter the "M System Setup" menu function.
3. The controller should display immediately "1 Dmx Ch". Press the **SETUP** button to select function.
4. Use the **UP** and **DOWN** buttons to increase or decrease the channel values. This value represents the starting address for this device. The controller occupies 4 channels of DMX
5. The unit will now respond to DMX command. Do not press any other buttons other than to change the channel values.

The next step may require you to create a device profile within your lighting controller. Proceed to section "DMX Channel Values" for a detailed chart of the control values for each channel of DMX.

### Running in DMX Mode

If the control panel menu displays "1 Dmx Ch" press **SETUP** to activate DMX control mode. For instructions on arriving at this menu item repeat the instructions "Setting the DMX address" located directly above this subject.

### Daisy Chain Connection

1. Connect the (male) 3 pin connector side of the DMX cable to the output (female) 3 pin connector of the first fixture.
2. Connect the end of the cable coming from the first fixture which will have a (female) 3 pin connector to the input connector of the next fixture consisting of a (male) 3 pin connector. Then, proceed to connect from the output as stated above to the input of the following fixture and so on.

## System Configuration & Connection

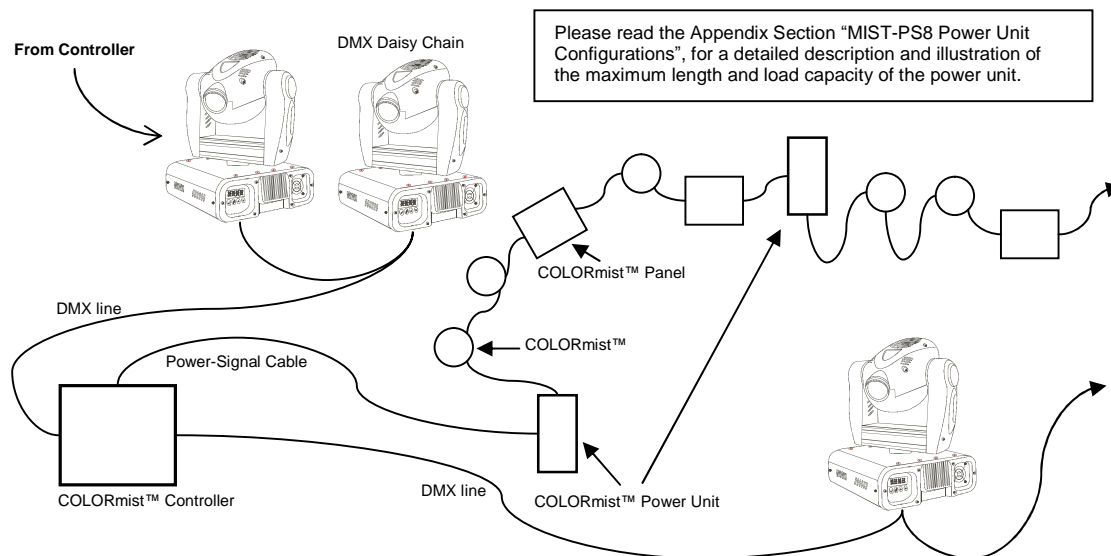

# APPENDIX

## DMX Primer

There are 512 channels in a DMX-512 connection. Channels may be assigned in any manner. A fixture capable of receiving DMX-512 will require one or a number of sequential channels. The user must assign a starting address on the fixture that indicates the first channel reserved in the controller. There are many different types of DMX controllable fixtures and they all may vary in the total number of channels required. Choosing a start address should be planned in advance. Channels should never overlap. If they do, this will result in erratic operation of the fixtures whose starting address is set incorrectly. You can however, control multiple fixtures of the same type using the same starting address as long as the intended result is that of unison movement or operation. In other words, the fixtures will be slaved together and all respond exactly the same.

DMX fixtures are designed to receive data through a serial Daisy Chain. A Daisy Chain connection is where the DATA OUT of one fixture connects to the DATA IN of the next fixture. The order in which the fixtures are connected is not important and has no effect on how a controller communicates to each fixture. Use an order that provides for the easiest and most direct cabling. Connect fixtures using shielded two conductor twisted pair cable with three pin XLR male to female connectors. The shield connection is pin 1, while pin 2 is Data Negative (S-) and pin 3 is Data positive (S+). CHAUVET carries 3-pin XLR DMX compliant cables, DMX-10 (33'), DMX-4.5 (15') and DMX-1.5 (5')

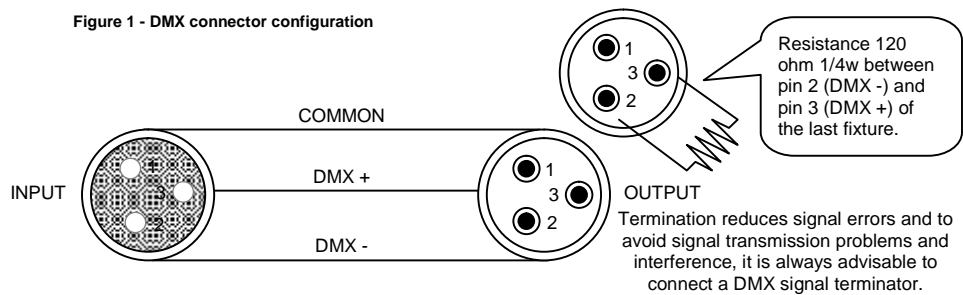

## Fixture Linking

**Note!**

**If you use a controller with a 5 pin DMX output connector, you will need to use a 5 pin to 3 pin adapter. CHAUVET Model No: DMX5M. The chart below details a proper cable conversion:**

3 PIN TO 5 PIN CONVERSION CHART

Conductor	3 Pin Female (output)	5 Pin Male (Input)
Ground/Shield	Pin 1	Pin 1
Data ( - ) signal	Pin 2	Pin 2
Data ( + ) signal	Pin 3	Pin 3
Do not use		Do not use
Do not use		Do not use

## DMX Channel Values

DEFAULT	VALUE	FUNCTION
1		<b>Programs</b>
	000 ⇔ 009	Black
	010 ⇔ 019	Red
	020 ⇔ 029	Green
	030 ⇔ 039	Blue
	040 ⇔ 049	Yellow
	050 ⇔ 059	Purple
	060 ⇔ 069	Light Blue
	070 ⇔ 079	White
	080 ⇔ 089	Color Change
	090 ⇔ 099	Slow Flow 1
	100 ⇔ 109	Slow Flow 2
	110 ⇔ 119	Roll Chase 1
	120 ⇔ 129	Roll Chase 2
	130 ⇔ 139	Multi Color
	140 ⇔ 149	Fast Flow 1
	150 ⇔ 159	Fast Flow 2
	160 ⇔ 169	Fast Flow 3
	170 ⇔ 179	Fast Flow 4
	180 ⇔ 189	2 Color Chase
	190 ⇔ 199	2 Color Flow
200 ⇔ 209	<b>Any Color:</b> Activates Red, Green & Blue Intensity controls	
210 ⇔ 219	Color Fade	
220 ⇔ 255	Auto Run	
2		<b>Run Speed</b> Slow > Fast, (1 step/Minute) > (100 steps/Second)
	000 ⇔ 255	<b>Any Color (Active)</b> <b>Red:</b> Intensity: 0% > 100
3	000 ⇔ 002	<b>Flash Speed</b> Always On
	003 ⇔ 249	Slow > Fast
	250 ⇔ 255	Blackout
	000 ⇔ 255	<b>Any Color (Active)</b> <b>Green:</b> Intensity: 0% > 100
4	000 ⇔ 012	<b>Color Combinations</b> Red & Green
	013 ⇔ 025	Red & Yellow
	026 ⇔ 038	Red & Blue
	039 ⇔ 051	Red & Purple
	052 ⇔ 064	Red & Cyan
	065 ⇔ 077	Red & White
	078 ⇔ 090	Green & Yellow
	091 ⇔ 103	Green & Blue
	104 ⇔ 116	Green & Purple
	117 ⇔ 129	Green & Cyan
	130 ⇔ 142	Green & White
	143 ⇔ 155	Yellow & Blue
	156 ⇔ 168	Yellow & Purple
	169 ⇔ 181	Yellow & Cyan
	182 ⇔ 194	Yellow & White
	195 ⇔ 207	Blue & Purple
	208 ⇔ 220	Blue & Cyan
	221 ⇔ 233	Blue & White
	234 ⇔ 246	Purple & Cyan
	247 ⇔ 255	Purple & White
000 ⇔ 255	<b>Any Color (Active)</b> <b>Blue:</b> Intensity: 0% > 100	
Refer to the Single Actions Program Chart on page 8 to determine if a Run Speed, Flash Speed and/or Color Combinations become functional. Not all functions are available to all preset programs listed.		

## MIST-PS8 (Power Unit) Configurations

The MIST-PS8 provides power to both the Panel and Par LED fixtures. The diagram below illustrates the number of fixtures along with the cable length the power unit is capable of accommodating.

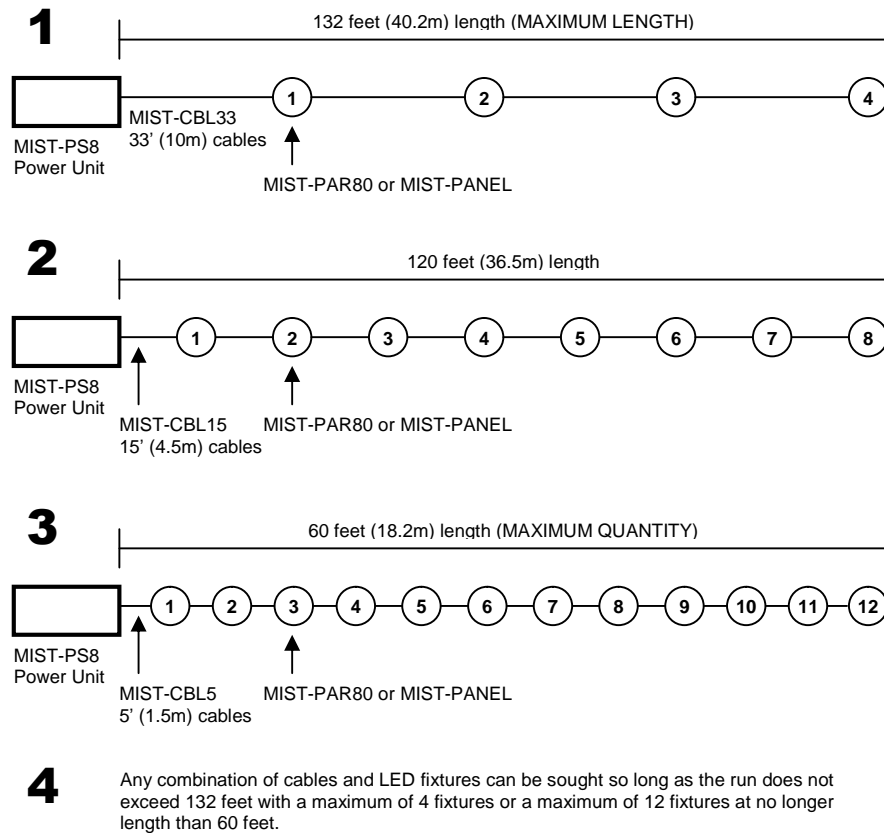

## Returns Procedure

Returned merchandise must be sent prepaid and in the original packing, call tags will not be issued. Package must be clearly labeled with a Return Merchandise Authorization Number (RA #). Products returned without an RA # will be refused. Call CHAUVET and request RA # prior to shipping the fixture. Be prepared to provide the model number, serial number and a brief description of the cause for the return. Be sure to properly pack fixture, any shipping damage resulting from inadequate packaging is the customer's responsibility. CHAUVET reserves the right to use its own discretion to repair or replace product(s). As a suggestion, proper UPS packing or double-boxing is always a safe method to use.

## Claims

Damage incurred in shipping is the responsibility of the shipper; therefore the damage must be reported to the carrier upon receipt of merchandise. It is the customer's responsibility to notify and submit claims with the shipper in the event that a fixture is damaged due to shipping. Any other claim for items such as missing component/part, damage not related to shipping, and concealed damage, must be made within seven (7) days of receiving merchandise.

## Technical Specifications

### MIST-PANEL

Length.....	302 mm (11.88 in)
Width.....	305 mm (12 in)
Height.....	29 mm (1.13 in)
Weight.....	2.22 Kgs (4.9 lbs)
Power.....	via MIST-PS8 Power Unit
Bulb.....	72 LEDs (100,000 hours)

### MIST-PAR80

Length.....	140 mm (5.5 in)
Width.....	174 mm (6.88 in)
Height.....	184 mm (7.25 in)
Weight.....	0.52 Kgs (1.15 lbs)
Power.....	via MIST-PS8 Power Unit
Bulb.....	80 LEDs (100,000 hours)

### MIST-PS8

Length.....	273 mm (10.75 in)
Width.....	273 mm (10.75 in)
Height.....	47.6 mm (1.88 in)
Weight.....	1.60 Kgs (3.55 lbs)
Power.....	Switchable 110V/230V or 230V

### MIST-CON

Length.....	213 mm (8.38 in)
Width.....	213 mm (8.38 in)
Height.....	47.63 mm (1.88 in)
Weight.....	0.70 Kgs (1.55 lbs)
Power.....	12V DC 800mA
Data input.....	locking 3-pin XLR male socket
Data output.....	locking 3-pin XLR female socket
Data pin configuration.....	pin 1 shield, pin 2 (-), pin 3 (+)
Protocols.....	DMX-512 USITT
Channels.....	4

### ORDERING INFORMATION

COLORmist™.....	MIST-PAR80
COLORmist™ Panel.....	MIST-PANEL
COLORmist™ Power 8.....	MIST-PS8
COLORmist™ Controller.....	MIST-CON
COLORmist™ Power/Signal Cable 33'.....	MIST-CBL33
COLORmist™ Power/Signal Cable 15'.....	MIST-CBL15
COLORmist™ Power/Signal Cable 5'.....	MIST-CBL5
COLORmist™ PAR Pack.....	SYS-PAR4
COLORmist™ Panel Pack.....	SYS-PANEL2

## Technical Support

Address:	Service Dept. 3000 N 29 <sup>th</sup> Ct, Hollywood, FL 33020 (U.S.A.)
Support (Email):	<a href="mailto:tech@chauvetlighting.com">tech@chauvetlighting.com</a>
Telephone:	(954) 929-1115 - (Press 4)
Fax:	(954) 929-5560 - (Attention: Service)
Website:	<a href="http://www.chauvetlighting.com">http://www.chauvetlighting.com</a>