

Modular Video Panel

# MVP™

Series

---

## Getting Started User Manual

---

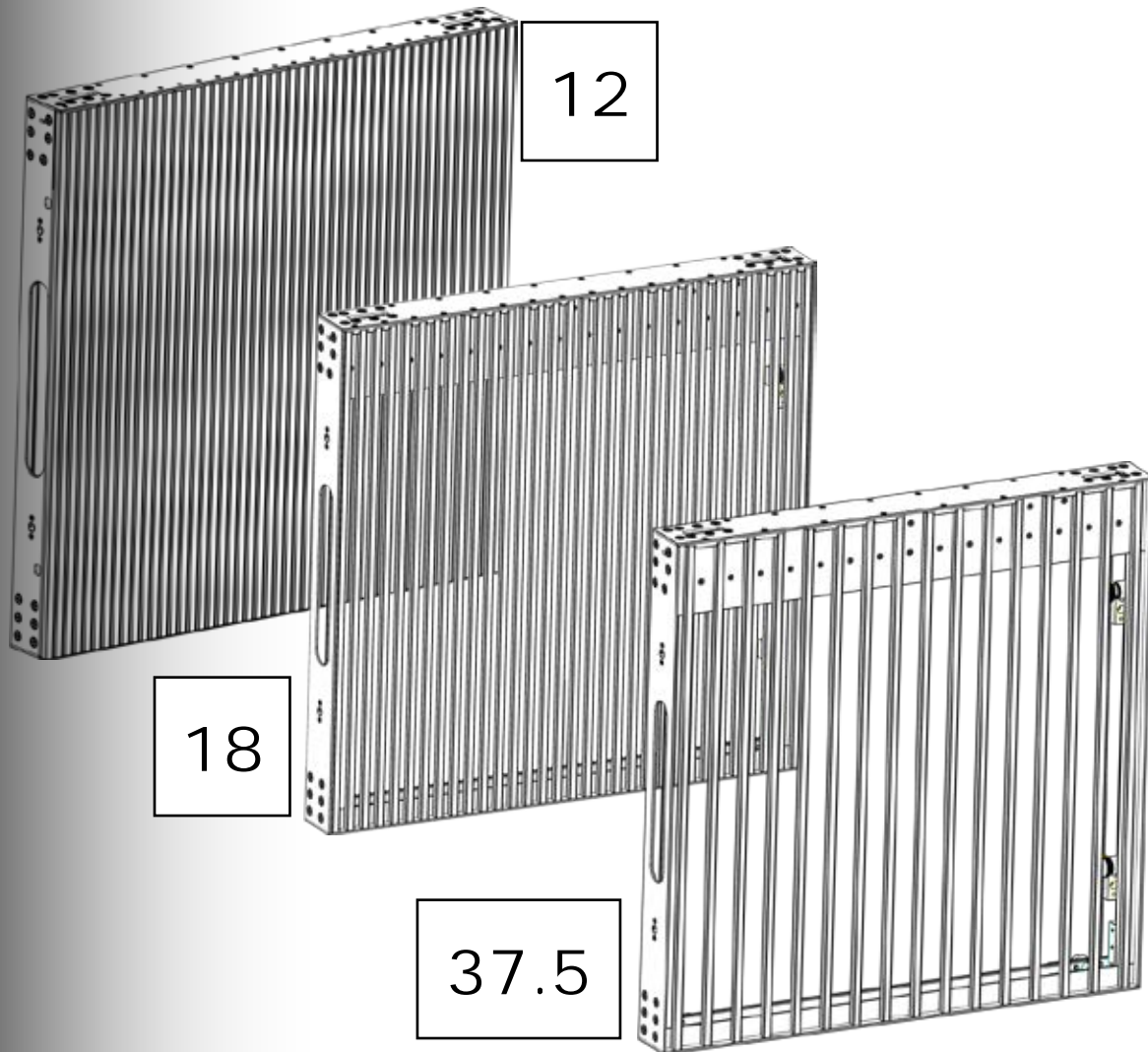

**CHAUVET**®  
*It's Green Thinking*

## Edition Notes

This User Manual covers the description, safety precautions, setup, installation, operation, and maintenance for all 3 Modular Video Panels offered by CHAUVET®. This edition was published in January 2012.

## Trademarks

CHAUVET® is a registered trademark of CHAUVET & Sons Inc. (d/b/a CHAUVET® or Chauvet). The CHAUVET® logo in its entirety including the Chauvet name and the dotted triangle, and all other trademarks on this manual pertaining to services, products, or marketing statements (example: It's Green Thinking™) are owned or licensed by CHAUVET®. Any other product names, logos, brands, company names, and other trademarks featured or referred to within this document are the property of their respective trademark holders.

## Copyright Notice

CHAUVET® owns the content of this user manual in its entirety, including but not limited to pictures, logos, trademarks, and resources.

© **Copyright 2012 CHAUVET®. All rights reserved.**

Electronically published by CHAUVET® in the United States of America.

## Manual Usage

CHAUVET® authorizes its customers to download and print this manual for professional information purposes only. CHAUVET® expressly prohibits the usage, copy, storage, distribution, modification, or printing of this manual or its content for any other purpose without its written consent.

## Document Printing

For best results, print this document in color, on letter size paper (8.5 x 11 inches), double sided. If using A4 paper (210 x 297 mm), configure your printer to scale the content accordingly.

## Disclaimer

CHAUVET® believes that the information contained in this manual is accurate in all respects. However, CHAUVET® assumes no responsibility for any error or omissions in this document. CHAUVET® reserves the right to revise this document and to make changes from time to time in the content hereof without obligation of CHAUVET® to notify any person or company of such revision or changes. This does not constitute in any way a commitment by CHAUVET® to make such changes. CHAUVET® may issue a revision of this manual or a new edition of it to incorporate such changes.

## Document Revision

The **MVP™ Series Getting Started User Manual**, Rev. 10, supersedes all previous versions of this manual. Please discard any older versions of this manual you may have, whether in printed or electronic format, and replace them with this version.

Author	Date	Editor	Date
D. Coupe	2/14/12	S. Graham	2/14/12

# Table of Contents

<b>1. Before You Begin</b> .....	<b>1</b>
What Is Included .....	1
Unpacking Instructions .....	1
Claims .....	1
Typographic Conventions .....	1
Icon Meaning .....	1
Safety Notes .....	2
Expected LED Lifespan .....	2
<b>2. Introduction</b> .....	<b>3</b>
Product Description .....	3
Features .....	3
Additional Features .....	3
Additional Products .....	3
Optional Accessories .....	3
Available Signal and Power Cables (optional) .....	3
Product Overview: MVP™ 12, MVP™ 18, and MVP™ 37.5 .....	4
Product Dimensions .....	6
MVP™ Pixels Per Panel .....	6
<b>3. Setup</b> .....	<b>7</b>
AC Power .....	7
AC Plug .....	7
Power Linking .....	7
<b>4. Mounting</b> .....	<b>8</b>
Orientation .....	8
Truss Installation .....	8
<b>5. Joining Each MVP™ (Creating a Modular Design)</b> .....	<b>9</b>
Vertically Joining the Panels .....	9
Horizontally Joining Panels .....	11
<b>6. Connecting (Cabling) Each MVP™</b> .....	<b>12</b>
Testing Signal and Power Connections .....	12
Using the MVP™ Test Button .....	12
Connecting the Signal Input .....	13
Connecting Power and Signal Cables .....	14
Connecting the Signal Between Joined Panels .....	14
Connecting the Power Between Joined Panels .....	16
<b>7. Typical MVP™ Installation</b> .....	<b>17</b>
Step 1 .....	17
Step 2 .....	17
Step 3 .....	17
Step 4 .....	17
Step 5 .....	17
Step 6 .....	17
Step 7 .....	17
MVP™ Sample Video Wall System Setup .....	18



---

<b>8. Operation .....</b>	<b>19</b>
Additional Hardware and Software .....	19
About LED Studio .....	20
Description.....	20
<b>9. Technical Information .....</b>	<b>21</b>
MVP™ Maintenance .....	21
Troubleshooting User Manual .....	21
Returns Procedure.....	22
Contact Us.....	22
<b>10. Technical Specifications .....</b>	<b>23</b>

# 1. Before You Begin

## What Is Included

- Two (2) or Six (6) MVPs (Modular Video Panels) models 12, 18, or 37.5
- One Neutrik® etherCON® Signal Cable per MVP™ 0.4 m/15.8 in
- One Neutrik® powerCON® Power Cable per MVP™ 0.4 m/15.8 in
- One 2- or 6-Pack Flight Case (based on the number of MVPs included)
- One Warranty Card
- One Getting Started User Manual

## Unpacking Instructions

Immediately upon receiving this product, carefully unpack and check the container. Make sure you have received all the parts indicated above in good condition.

## Claims



Upon receipt, if the container or the material inside the container (the product and included accessories) appear damaged from shipping, or show signs of mishandling, notify the carrier immediately, not CHAUVET®. Failure to do so in a timely manner may invalidate your claim with the carrier. In addition, keep the container and all the packing material for inspection.

For other issues such as missing components or parts, damage not related to shipping, or concealed damage, file a claim with CHAUVET® within seven (7) days of receiving the merchandise.

## Typographic Conventions

Convention	Meaning
<b>1~512</b>	A range of values in the text
<b>50/60</b>	A set of mutually exclusive values in the text
<b>Italics</b>	A reference to a section, chapter, or external document
<b>&lt;SET&gt;</b>	A button on the product's control panel
<b>Settings</b>	A product function or a menu option
<b>MENU à Settings</b>	A sequence of menu options
<b>1~10</b>	A range of menu values from which to choose in a menu
<b>Yes/No</b>	A set of two mutually exclusive menu options in a menu
<b>ON</b>	A unique value to be entered or selected in a menu

## Icon Meaning

Icon	Meaning
	Critical installation, configuration, or operation information. Failure to comply with this information may render the product partially or completely inoperative, damage third-party equipment, or cause harm to the user.
	Important installation or configuration information. Failure to comply with this information may prevent the product from functioning correctly.
	Useful, non-critical information.

## Safety Notes

Please read the following Safety Notes carefully before starting to work with the product. These notes provide important safety information about the installation, usage, and maintenance.



**This product contains no user-serviceable parts. Any reference to servicing in this User Manual will only apply to properly trained CHAUVET® certified technicians. Do not open the housing or attempt any repairs.**



**Please refer to all applicable local codes and regulations for the proper installation of the product.**

- Always connect the product to a grounded circuit to avoid the risk of electrocution.
- The product is rated IP54 and should only be used in environments meeting that criteria.
- When hanging the product, always secure to a fastening device using a safety cable.
- The maximum ambient temperature is 122° F (50° C). Do not operate the product at higher temperatures.
- Do not operate the product if you see damage on the housing, LED strips, or cables. In any of these cases, have the damaged parts replaced by an authorized technician.
- Do not open or modify the product.
- Make sure the product is connected to the proper voltage provided in this manual's specifications and/or the specification sticker on the product.
- Never try to repair the product. Repairs carried out by unskilled people can lead to damage or malfunction. Please contact CHAUVET® Technical Support.



**Any damages caused by manual modifications are not subject to warranty. CHAUVET® will not accept liability for any resulting damages caused by unauthorized modifications or not observing the safety warnings and instructions in the manual.**



**In the unlikely event that your CHAUVET® product may require service, contact CHAUVET® Technical Support.**

## Expected LED Lifespan

LEDs gradually decline in brightness over time, mostly because of heat. Packaged in clusters, LEDs exhibit higher operating temperatures than in ideal, single LED conditions. For this reason, using clustered LEDs at their fullest intensity significantly reduces the LEDs' lifespan. The electrical, thermal management design of the MVP™ panel is designed to provide the longest LED lifespan possible. Under normal operating conditions, this lifespan can be 50,000 hours or longer. If extending this lifespan is vital, lower the operational temperature by improving ventilation around the fixture and reducing the ambient temperature to an optimal operating range. In addition, limiting the overall projection intensity may also help to extend the LEDs' lifespan.

## 2. Introduction

### Product Description

The MVP™ is a Modular Video Panel. The MVP™ series includes three models:

- MVP™ 12
- MVP™ 18
- MVP™ 37.5

Each model is a panel consisting of multiple LED full-color light strips. The number in each model name indicates the pixel pitch (distance, in millimeters, between the LED light strips) of that model. When multiple panels are assembled and connected (signal and power), the entire configuration becomes a modular video wall design.

The outer dimensions of each panel are identical. The difference between each model is the spacing between the LED light strips and the number of LED pixels on each strip. Both of these values determine the total number of LED pixels provided on each panel. Each pixel is one SMD5050 LED.

The aluminum alloy and stainless steel construction make the MVP™ reliable and solid, as well as easy to install and dismantle. You can assemble multiple panels horizontally or vertically, and each model is interchangeable with the others. This flexibility provides numerous modular design possibilities.

The MVP™ video wall system is controlled using a PC and the LED Studio software available as download from the Internet. Refer to the **LED Studio User Manual** for detailed information and instructions on using LED Studio.

### Features

- Packaged in a convenient CHAUVET® flight case that includes either two (2) or six (6) MVP™ panels
- Lightweight, modular system
- Provides multiple graphics based on which MVP™ is used and how the video wall is assembled
- Uses Neutrik® powerCON® and Neutrik® etherCON® connectors for easy installation and connectivity
- Perfect for long-term installations
- Each MVP™ is interchangeable for creative modular video wall designs
- Tri-color SMD LEDs provide better image quality and wider viewing angle
- Designed for indoor or temporary outdoor installations
- Easily viewed during daylight operation

### Additional Features

- One Neutrik® etherCON® signal cable per MVP™ 0.4 m/15.8 in
- One Neutrik® powerCON® power cable per MVP™ 0.4 m/15.8 in

### Additional Products

- MVP™ Driver (required)
- MVP™ 526P Signal Processor (processor required for alternate video sources)

### Optional Accessories

- MVP™ Signal Distributor (required when using 25 MVPs or more in your video wall)
- MVP™ Rigging Kit (required when you hang panels from a truss or truss structure)

### Available Signal and Power Cables (optional)

- Signal cables (Neutrik® etherCON® Signal Extensions)
  - MVPU-SIG5FT      · MVPU-SIG10FT      · MVPU-SIG25FT
- Power cables (Neutrik® powerCON® Extension)
  - PCEXT5FT      · PCEXT10FT      · PCEXT25FT      · PCLEAD50FT

## Product Overview: MVP™ 12, MVP™ 18, and MVP™ 37.5

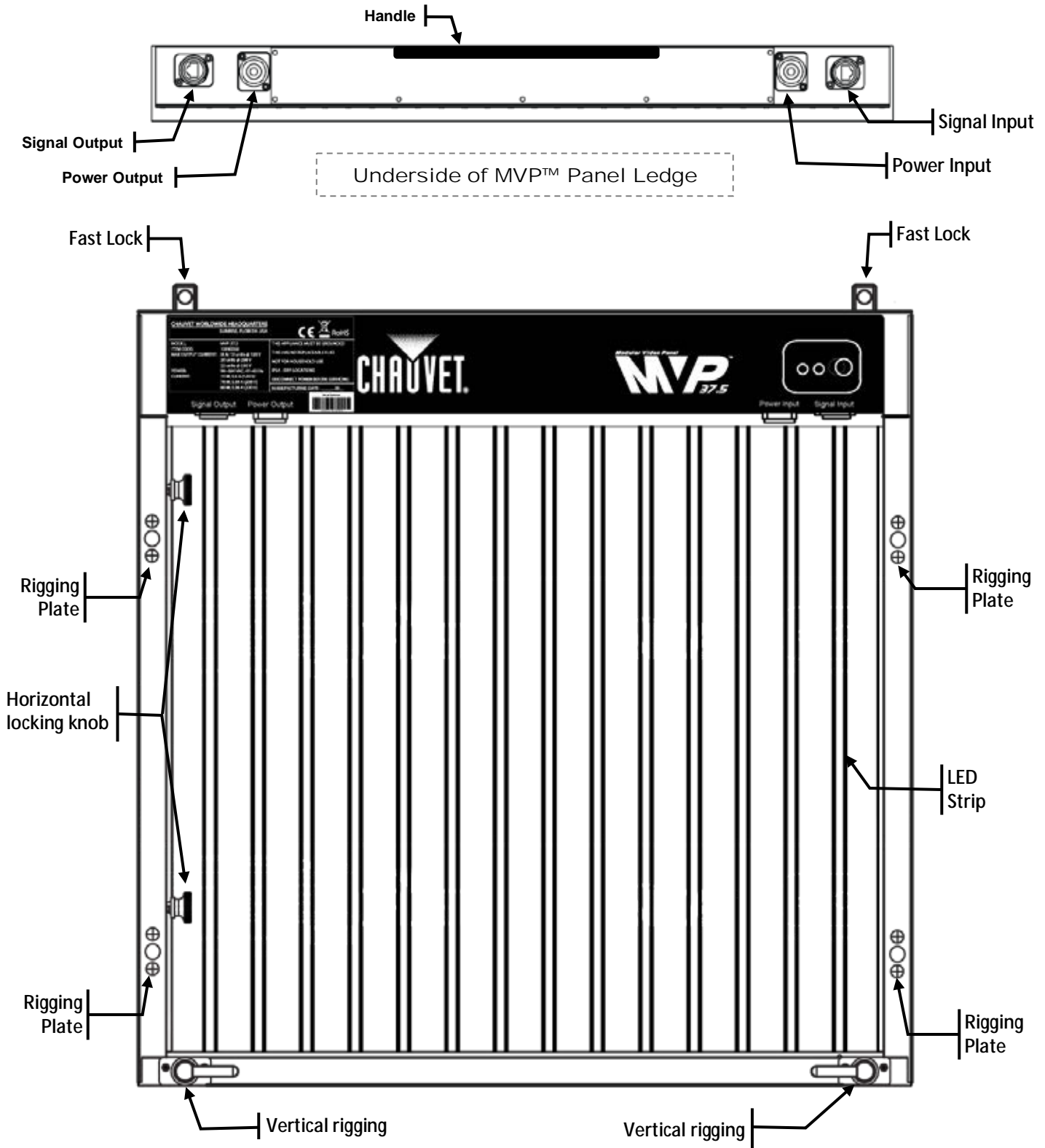





The difference between each MVP™ model is the pixel pitch (space) between the LED strips and the number of pixels (LEDs) on each strip. The basic housing and components are identical. Refer to the previous MVP™ 37.5 illustration.

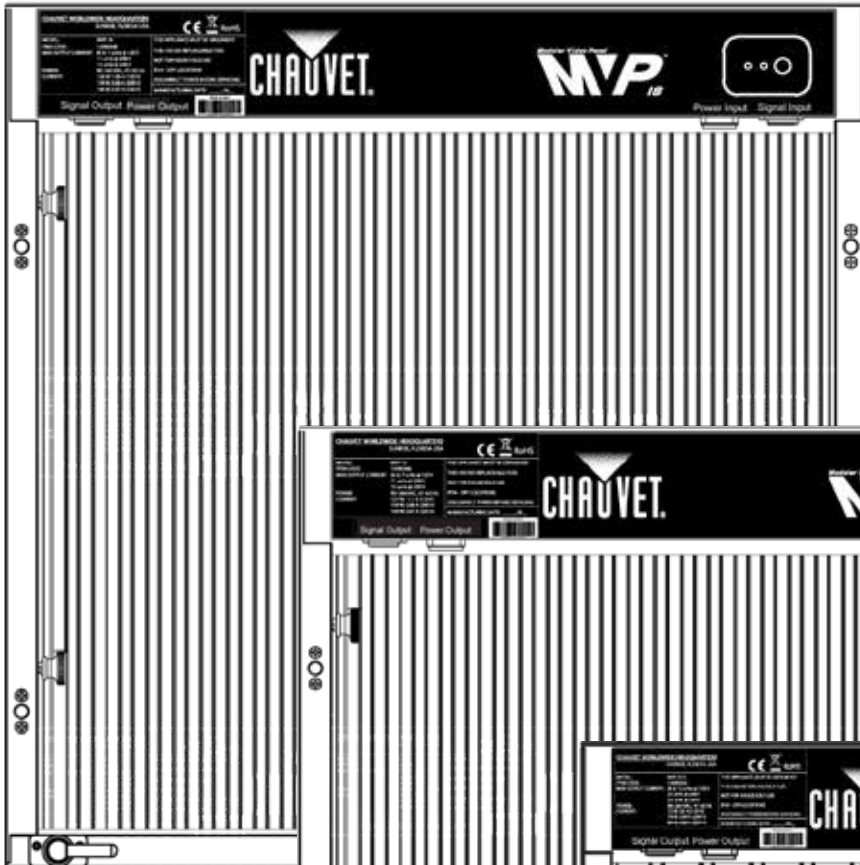

MVP™ 18

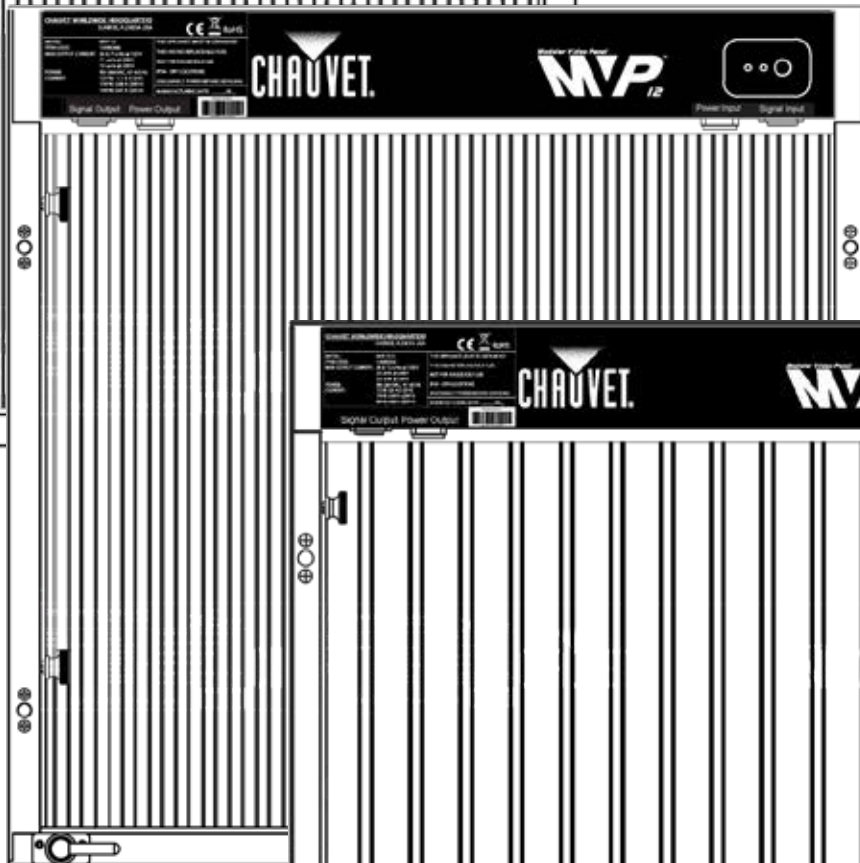

MVP™ 12

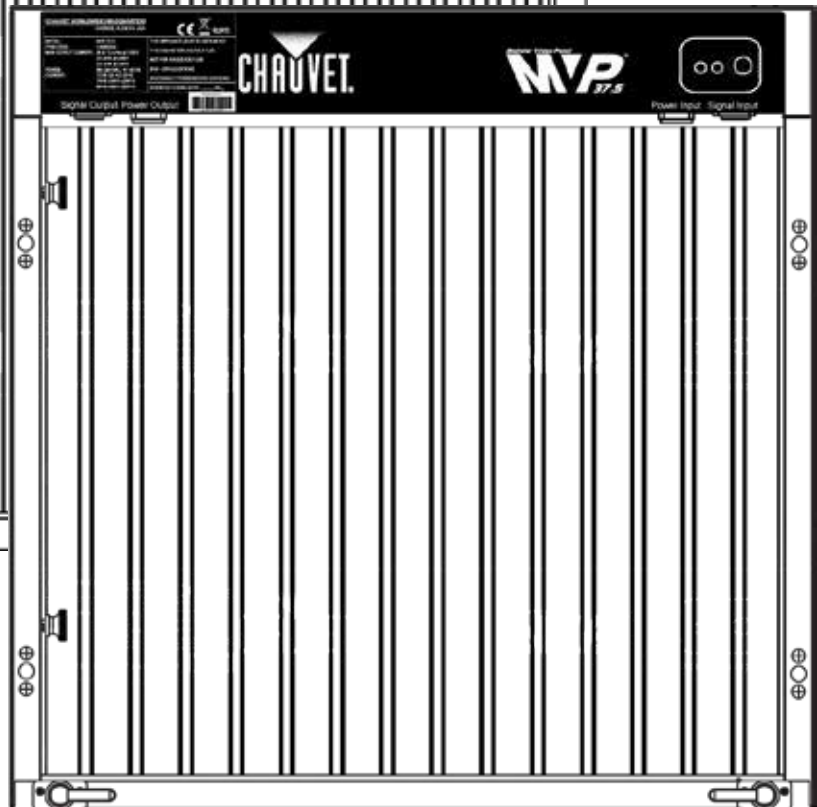

MVP™ 37.5

## Product Dimensions

 Each MVP™ model in the series has the same outside housing dimensions.

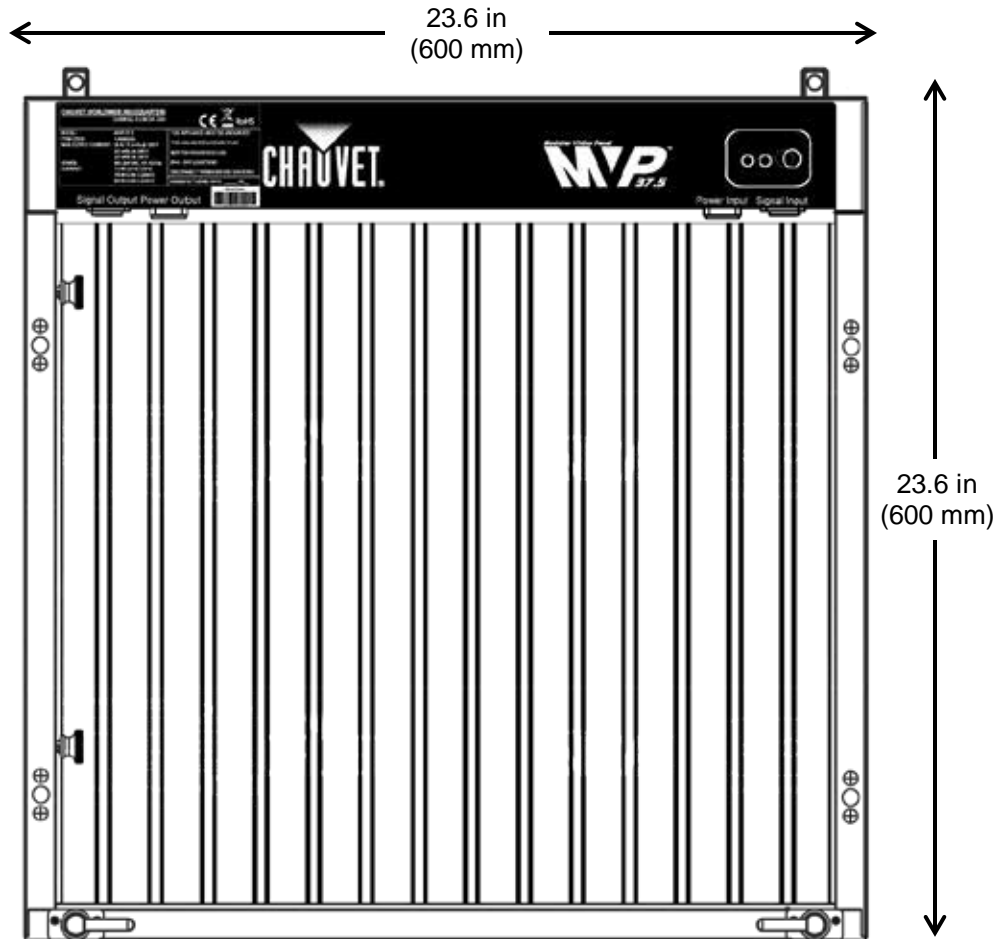

### MVP™ Pixels Per Panel

Although each MVP™ has the same outer dimensions, the LED pixels per panel vary. Each pixel is one SMD5050 LED. The following table provides the pixels per panel in each MVP™. The Series number (i.e., 37.5) indicates the pixel pitch in millimeters between each light strip in that MVP™ model. For detailed specifications, refer to the [Technical Specifications](#) table at the end of this User Manual.

	MVP™ 12	MVP™ 18	MVP™ 37.5
Pixels per Panel	48 x 48	32 X 32	16 X 16
<b>Total Pixels</b>	<b>2,304</b>	<b>1,024</b>	<b>256</b>



You will use the number of pixels per panel and the screen resolution you would like to use for your video wall display to calculate the number of panels, horizontally and vertically, supported by a single MVP™ Driver. This Driver is required to operate a CHAUVET® MVP™ video wall system. Diagrams of how the MVP™ panels and the MVP™ Driver operate together follow later in this manual. For detailed information about the MVP™ Driver and panel calculation examples, refer to the **MVP™ Driver Quick Reference Guide**.

### 3. Setup

#### AC Power

Each MVP™ has an auto-ranging power supply that works with an input voltage range of 100~240 VAC, 50/60 Hz.

Make sure that you are connecting the MVPs to the proper voltage, as specified in this User Manual and on the product's specification sticker.



**Always connect this product to a protected circuit with an appropriate electrical ground to avoid the risk of electrocution or fire.**

To determine the power requirements for each MVP™ in the series, refer to the label affixed to the product. You can also refer to the [Technical Specifications](#) chart in this manual.

The listed current rating indicates the maximum current draw during normal operation. For more information, you may download **Sizing Circuit Breakers** from the CHAUVET® website: [www.chauvetpro.com](http://www.chauvetpro.com).



**Never connect this product to a rheostat (variable resistor) or dimmer circuit, even if the rheostat or dimmer channel serves only as a 0% to 100% switch.**

#### AC Plug

Each MVP™ comes with a power linking cord to connect power between panels; however, the power input cord is not included.

The power input cord must be purchased separately. CHAUVET® recommends the Neutrik® powerCON® extension cable, item number PCEXT50FT, available from CHAUVET®.

This cable has a powerCON connector to connect to the MVP™ and a bare plug for power input. Use the table below as a reference to wire a new plug.

Connection	Wire (US)	Wire (Europe)	Screw Color
AC Live	Black	Brown	Yellow or Brass
AC Neutral	White	Blue	Silver
AC Ground	Green/Yellow	Green/Yellow	Green

#### Power Linking

All three panels in the Series support power linking. Refer to the following table for specifications on each panel.

	MVP™ 12	MVP™ 18	MVP™ 37.5
@ 120 V, 60 Hz	7	7	13
@ 208 V, 60 Hz	11	11	20
@ 230 V, 50 Hz	12	12	22



**Please refer to all applicable local codes and regulations for the proper installation of this product.**

# 4. Mounting

## Orientation

Each MVP™ is a solid frame constructed of aluminum alloy and stainless steel. This ensures each panel is stable and easy to install. Each panel also has a convenient built-in handle located on the top, underside, of the panel. This handle enables you to easily pick up and securely hold each panel while mounting and working with the panels.

The MVP™ can be assembled to provide any number of modular designs. The panels on the top can be securely hung from a truss or other stable surface. Always hang in a safe position with adequate space for ventilation, configuration, and maintenance.

CHAUVET® recommends following the general guidelines below.

- When selecting an installation location, consider ease of access for operation and routine maintenance.
- Make sure to hang away from any flammable material, as indicated in the Safety Notes section.
- Never mount in places where rain, extreme temperature changes, or restricted ventilation may affect it.
- Make sure that the structure to which you are hanging the panels can support the weight.

Please see the *Technical Specifications* section of this manual for the weight requirement of each MVP™.

## Truss Installation

Refer to the following diagram for truss installation. CHAUVET® offers the MVP™ Rigging Kit (sold separately) specifically designed for hanging the panels.

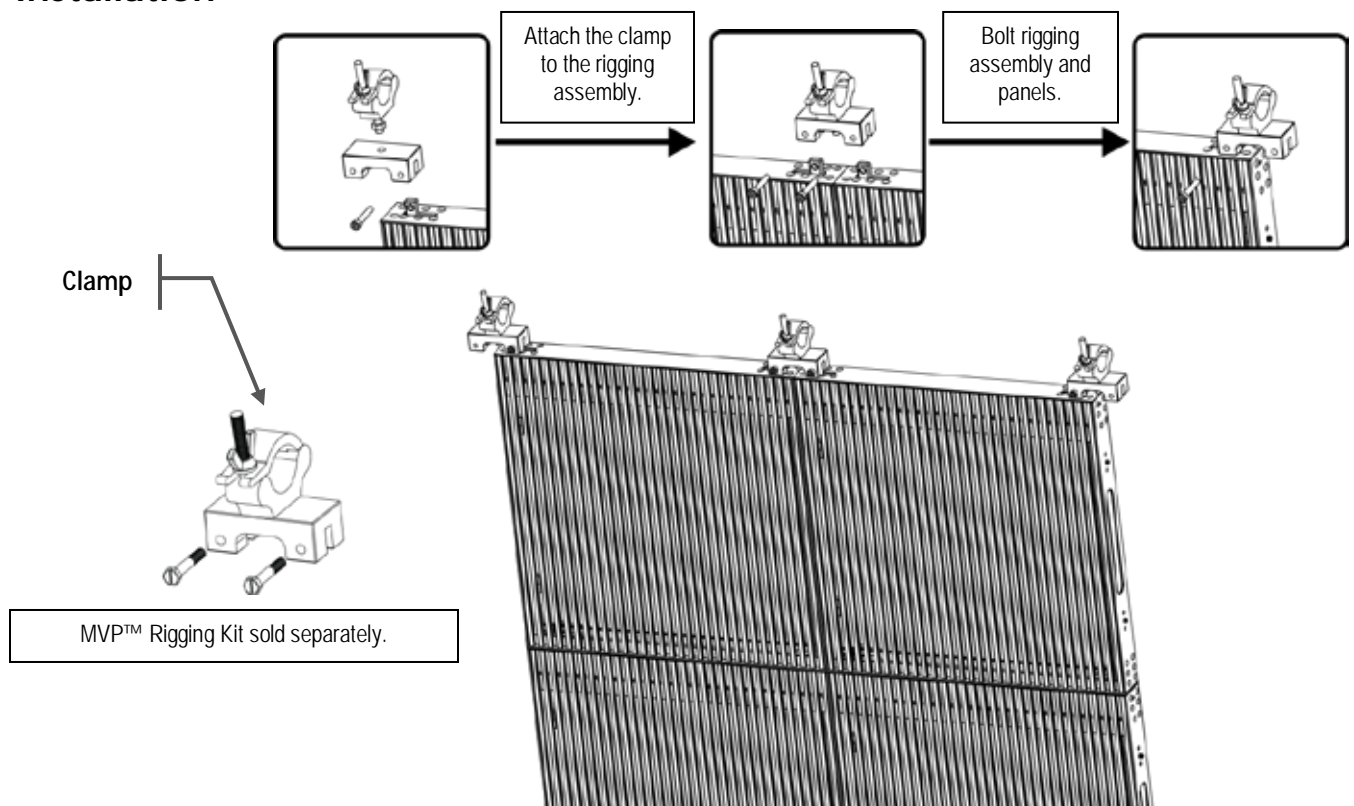

## 5. Joining Each MVP™ (Creating a Modular Design)

Each MVP™ is joined together to create a modular designed video wall. Because the panels are interchangeable, you can create a video wall by joining several of the same model or joining different models to create a larger or more complex video wall.

### Vertically Joining the Panels

Each MVP™ can be easily joined vertically using the two (2) fast locks located at the top corner of each panel and the vertical rigging located on the bottom of the panel at each corner. These connectors can be recessed if not being used.

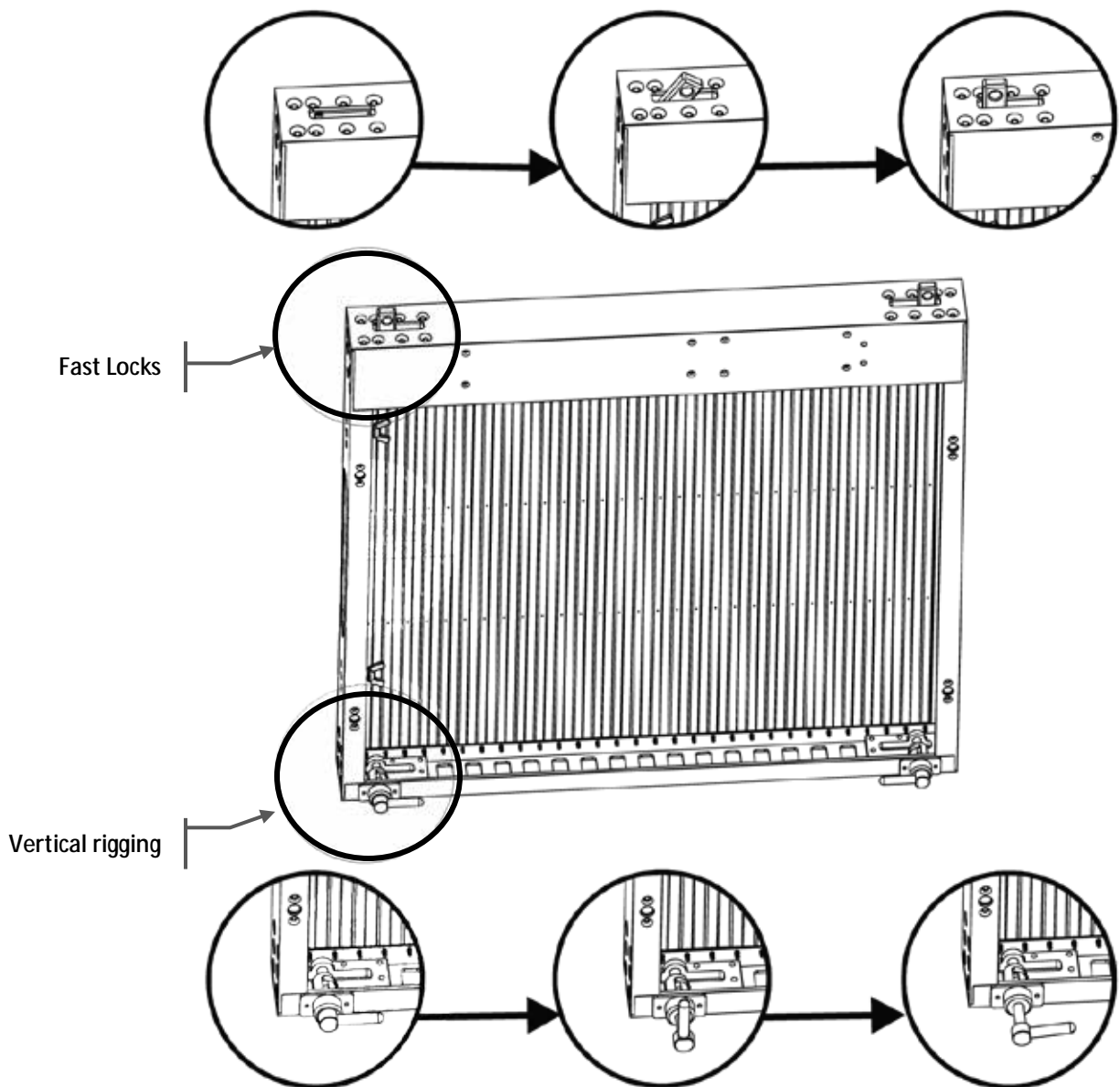

Use the following instructions to join your panels vertically. Each step corresponds to the number in the diagram.

1. When connecting two (2) panels, pull out the vertical rigging latch making sure it is pushed outward.
2. The fast locks on the lower panel should be pointing up.
3. Align the top and bottom panels exactly on top of each other. Push the vertical rigging inward to fasten.



**Once the panels are fastened, make sure you turn the vertical rigging latch toward the center of the panel to lock the panels in place.**

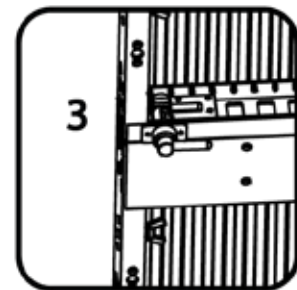
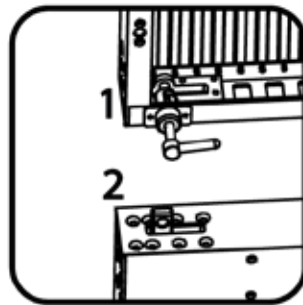

## Horizontally Joining Panels

Each MVP™ can be easily joined horizontally using the two horizontal locking knobs on the inside left-hand top and bottom of each panel.

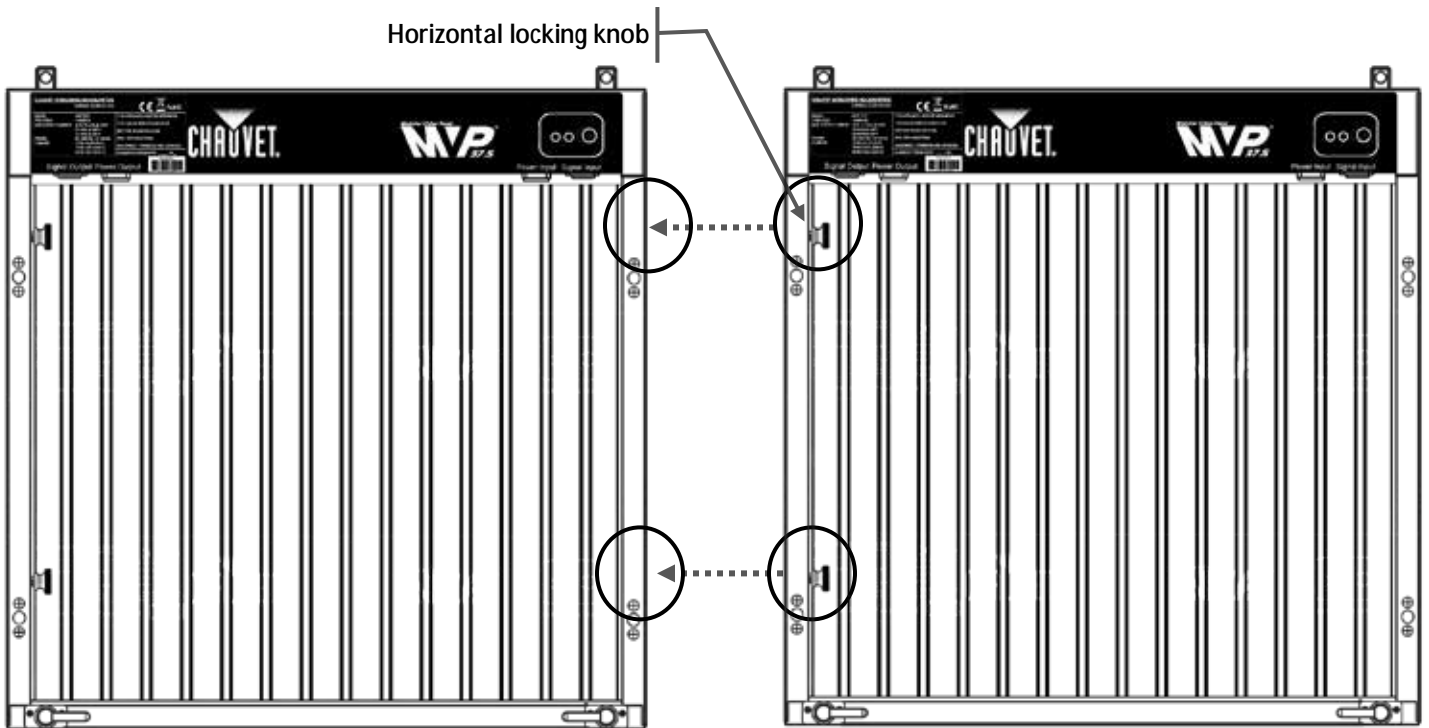

### Instructions:

1. Align each knob with the corresponding hole on the right-hand outside of the panel to which you are joining.
2. Once aligned, push in and twist clockwise a quarter-turn to lock the two panels horizontally together.
3. You will feel the two panels lock together.

## 6. Connecting (Cabling) Each MVP™

### Testing Signal and Power Connections

Each MVP™ has two (2) power supply sockets and two (2) signal sockets.

- The Power and Signal **IN** are located on the upper right-hand corner of each panel.
- The Power and Signal **OUT** are located on the upper left-hand corner of each panel.
- The Signal **IN** and **OUT** may be used interchangeably.

Each MVP™ has LED indicator lights.

- Each panel indicates a successful power connection when the Power indicator light remains red.
- Each panel indicates video signal reception when the Signal LED indicator light displays green. This light should be blinking rapidly to indicate good reception.

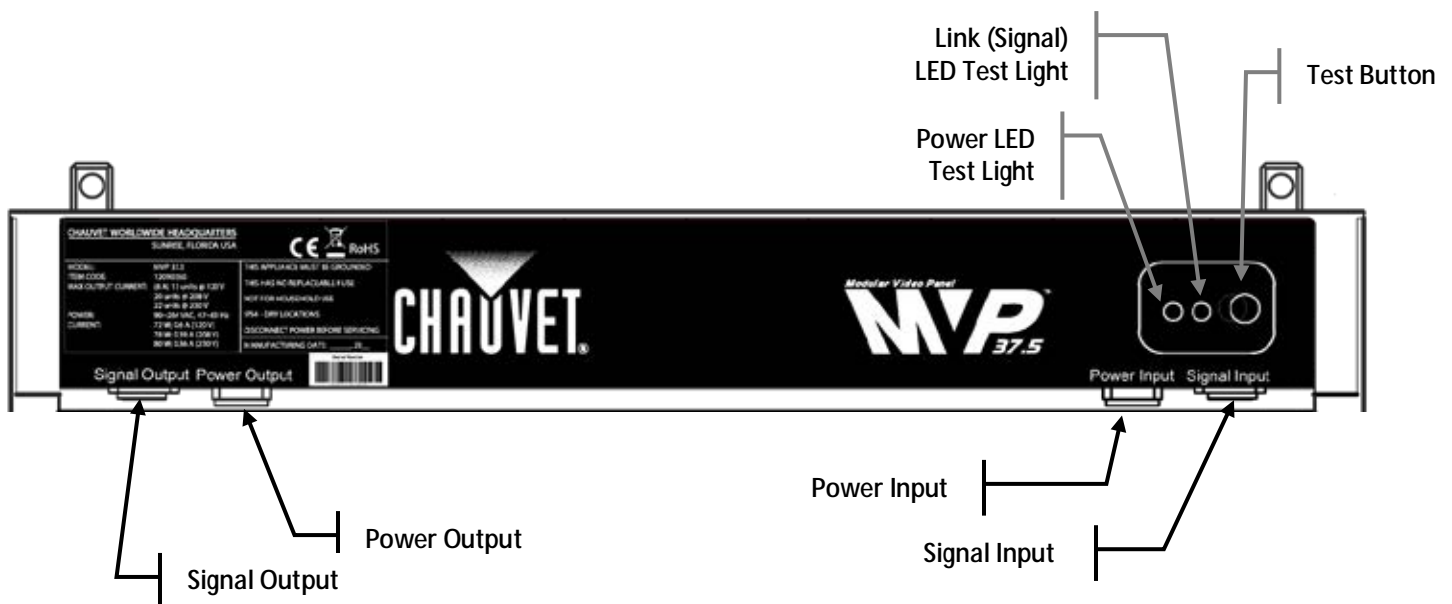

### Using the MVP™ Test Button

Each MVP™ also has a Test button, used to ensure all LED strips in each panel are functional. Use the Test Button on each panel to perform a self-test. If self-testing, you must perform the test individually for each MVP™. You do not need to connect to a signal or use software.



When using the Test button, make sure the MVP™ is not connected to the MVP™ Driver.

To use the Test Button, you must connect the power, but **do not** connect the signal cables.

1. Press the Test button to view various LED strip configurations on each MVP™.
2. Press the Test button one time and all the LED strips should display.
3. Press the Test button again to toggle through various LED light display configurations.



## Connecting the Signal Input

The MVP™ video wall system you design can use two basic setup configurations to connect the signal to the video wall: (1) a configuration using 24 or less panels, and (2) a configuration using more than 24 panels. Refer to the following diagrams. See the following section for connecting power to the MVP™ system, and connecting power and signal between joined panels.

- 1 The following configuration of 24 panels shows a direct connection from the signal to the MVP™ Driver into the first panel's Signal Input socket. Refer to the **MVP™ Driver Quick Reference User Manual** for information and instructions on the MVP™ Driver.

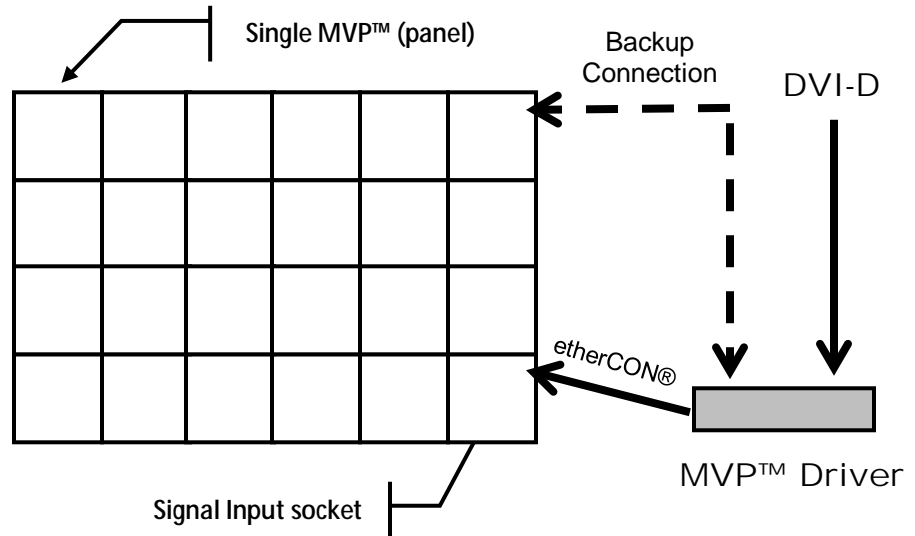

**The MVP™ system maximum signal load is 24 or less panels on a single signal cable connection.** When using more than 24 panels in a video wall design, you will need a MVP™ Signal Distributor and additional signal cables to accommodate the number of panels over 24. An MVP™ Signal Distributor output supports up to 8 signal output lines, providing up to 192 total panels that can be connected from the MVP™ Signal Distributor. You also can add more MVP™ Signal Distributors to a MVP™ video wall system. Refer to the *MVP™ Signal Distributor Quick Reference Guide* for more information.

## Connecting Power and Signal Cables

The following sections provide information and diagrams on connecting signal and power between panels.

One Neutrik® etherCON® signal cable and one Neutrik® powerCON® power cable are included with each MVP™ package—one cable of each kind per MVP™ in the package. These cables are to be used for panel linking only. You are able to purchase additional cables.

Refer to the [Introduction](#) or [Operation](#) sections in this User Manual for available cables and item numbers.

## Connecting the Signal Between Joined Panels

Signal cable panel connections can use several different configurations. The basic configuration to connect the signal from one panel to the next is as follows.

- The source signal is connected to the first panel's Signal Input or Output.
- A signal cable is then connected to the first panel's Signal Output and connected to the next panel's Signal Input.
- The connections continue until all panels are connected.
- The direction of the cables used to make the signal connections can vary.

The following diagrams are recommended suggestions for signal connections between 24 or less panels, and more than 24 panels.

Refer to [Connecting Signal Input](#) for information and instructions on connecting the signal from the source.

1 This diagram shows an example of a simple signal connection using 24 or less MVPs.

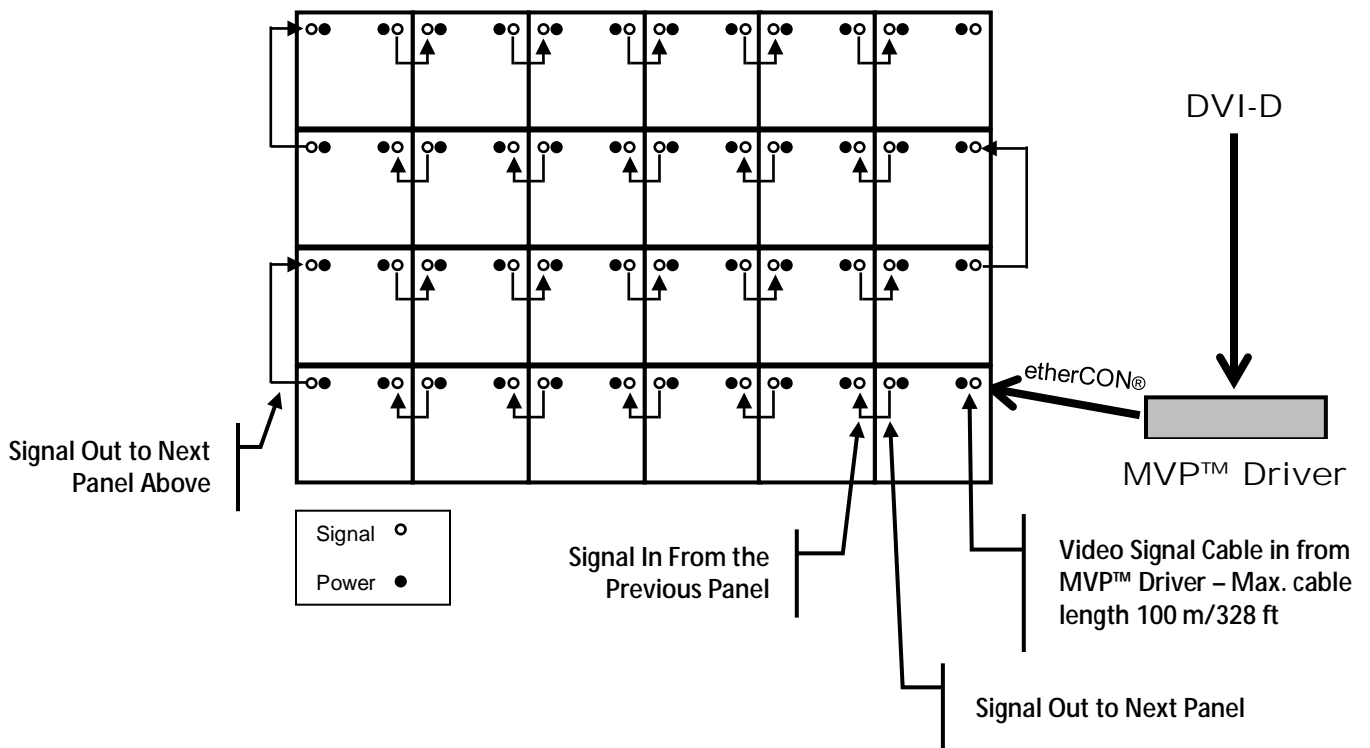

The following diagram shows an example of a signal connection configuration using more than 24 panels. A video wall design with more than 24 panels requires:

- Incoming signal connection to the MVP™ Driver.
- MVP™ Driver connection to the MVP™ Signal Distributor.
- Signal cable connections as determined by the number of panels in the video wall design.



Every group of 24 panels will require another signal cable from the MVP™ Signal Distributor. Eight (8) signal cables can be connected to a single MVP™ Signal Distributor.

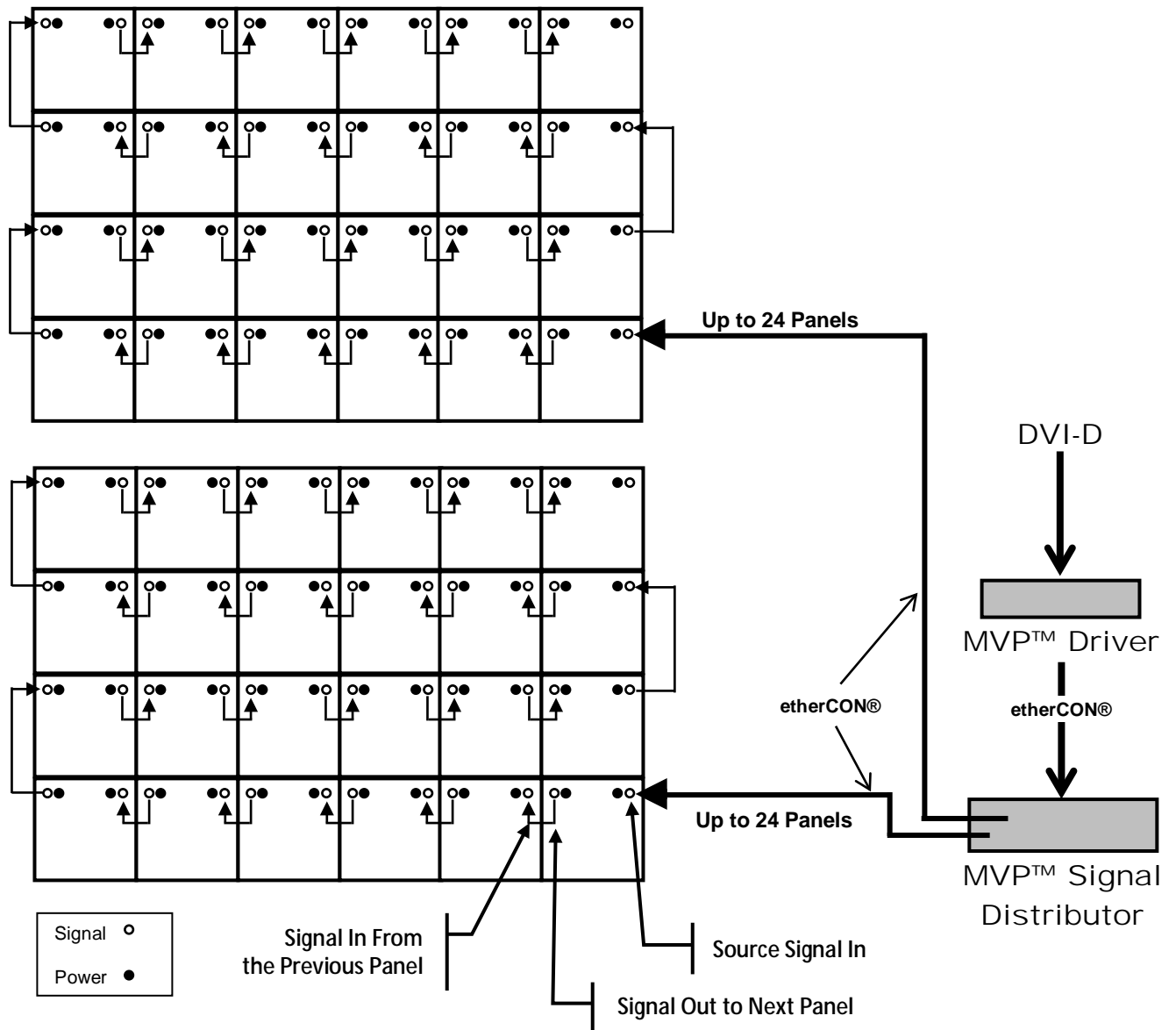

### Connecting the Power Between Joined Panels



Power cable panel connections can also use different configurations. The basic configuration to connect the main power supply from one panel to the next is as follows.

- The main power is connected to the first panel's Power Input or Output.
- A powerCON® cable is then connected to the first panel's Power Output and connected to the next panel's Power Input.
- The connections continue until all panels are connected.
- The direction of the cables used to make the power connections can vary.

The power input cord for the main must be purchased separately. CHAUVET® recommends the Neutrik® powerCON® extension cable, item number PCLEAD50FT, available from CHAUVET®.

Connect power between the panels using the same procedure as the signal only using the Power Input and Power Output connectors. You must adhere to the power-linking specifications for each MVP™ model.

Refer to the [Power Linking](#) section for details on the number of panels that can be linked based on voltage from a single power connection.

Refer to the following diagram for an example of power connection from the main and to each connected panel.

This example is using an MVP™ 12 or 18, power linking 7 panels horizontally @ 120 V.

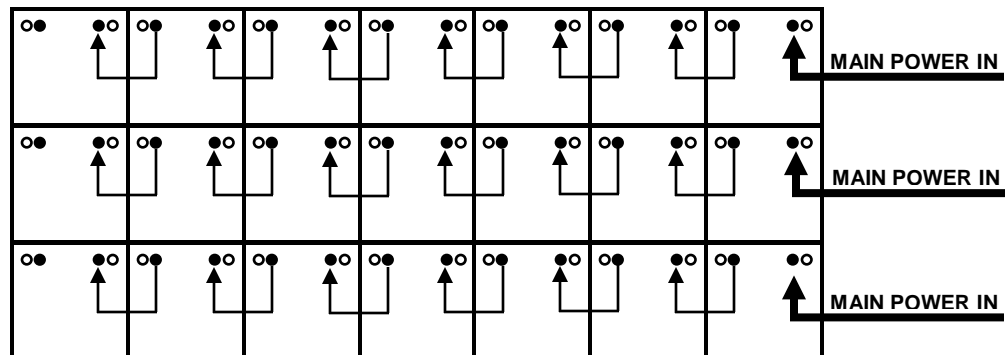

## 7. Typical MVP™ Installation

Because a video wall system can include different components to provide a simple to complex modular wall design, use the following steps as a general guide to get started.

- Step 1** Open and examine the MVP™ flight case to make sure you have received all products and accessories and that each one is in good condition.
- Step 2** Apply power and run the self-test for each MVP™ to ensure all LEDs and inside connections in each panel are working (optional).
- Step 3** Create a stable mounting surface (i.e., truss or other stable surface) for MVP™ mounting.
- Step 4** Mount the first top row of the MVPs. Refer to the [Mounting](#) section in this User Manual.
- Step 5** Based on your video wall configuration (design), join each panel, either horizontally or vertically, using the instructions in the section, [Joining Each MVP™](#).
- Step 6** Connect the signal source to the MVP™ Driver. Connect the MVP™ Driver to the MVP™ Signal Distributor (if applicable).
- Step 7** Connect either MVP™ Driver or MVP™ Signal Distributor (if being used) to the Input Signal socket of the first panel in your connection chain.  
Refer to the instructions and information in the section of this User Manual, [Connecting \(Cabling\) Each MVP™](#).

## MVP™ Sample Video Wall System Setup

The following diagram provides a sample setup for a CHAUVET® MVP™ video wall system. This system setup includes an optional MVP™ 526P Signal Processor for additional video sources, and the MVP™ Signal Distributor to support more than 24 panels. Note that the two-driver setup shown here allows for simultaneous playback of pre-recorded and live content, all directed from a single PC.

Refer to the *MVP™ 526P Signal Processor Quick Reference Guide* and the *MVP™ Signal Distributor Quick Reference Guide* for information on those video wall components.

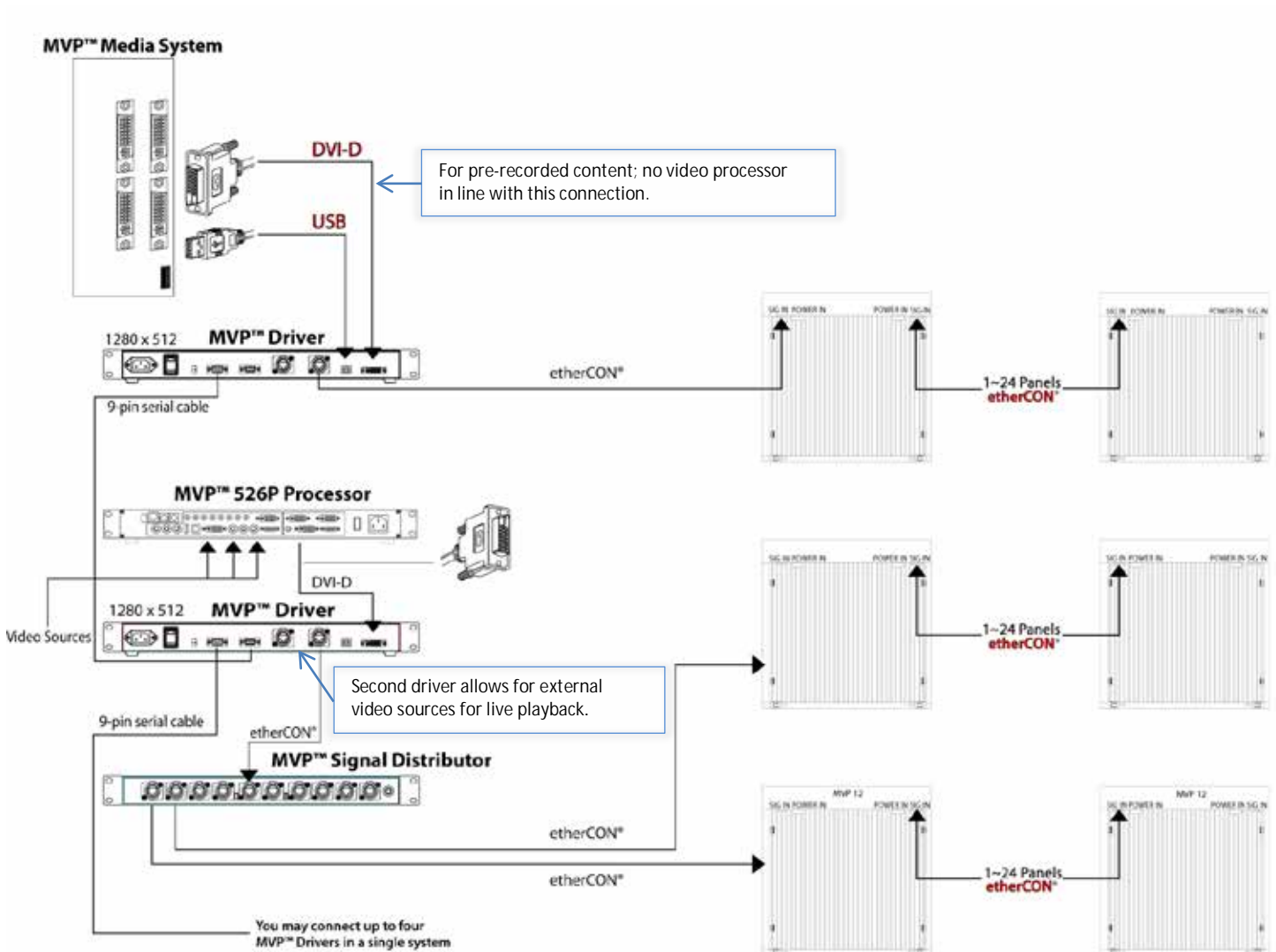

**MVP™ Media System Flexibility:** In this illustration, the top driver provides playback of pre-recorded content to the first series of panels, and the second driver receives video from external sources, allowing for playback of live content to the remaining panels. Both options can be configured by a single PC, with the content coming through either that PC or the MVP™ 526P Processor.

## 8. Operation

### Additional Hardware and Software

In addition to the panels, you will need other hardware and software to design, build, and operate your MVP™ video wall system. The following table summarizes these additional items—some are required and others are optional. At the bottom, all MVP™ flight case packages are also listed.

Item	Description	Item Code	Item Number
CHAUVET® Flight case (additional flight case)	Fits 2 MVP™ panels	12090370	MVPU-CASE2
MVP™ Driver	Interface between the signal source, LED Studio, and the MVP™ being used	12090357	MVPU-DRIVER
LED Studio	Software application used to design and run the MVPs comprising the video wall. A PC is needed		
MVP™ 526P Signal Processor & software	Connects the audio/video signals and PC to integrate and run the display on the MVP™ video wall		
MVP™ Signal Distributor (optional up to 24 panels)	Connects between the MVP™ Driver and the MVPs to distribute the source signal from the MVP™ Driver to the video wall when using more than 24 panels	12090360	MVPU-SIGDISTRO
MVP™ Rigging Kit (optional)	Provides hardware needed to mount MVPs. Rigging Kit Rigging Kit – single Rigging Kit – dual	12090352 12090355 12090356	MVP-RK MVP-RK1 MVP-RK2
Neutrik® etherCON® Signal Extension (optional)	MVP™ Signal Extension, 18 in MVP™ Signal Extension, 5 ft MVP™ Signal Extension, 10 ft	19090363 19090364 19090365	MVPU-SIG18IN MVPU-SIG5FT MVPU-SIG10FT
Neutrik® powerCON® Extension (optional)	powerCON® Extension, 18 in powerCON® Extension, 5 ft powerCON® Extension, 10 ft powerCON® Extension, 25 ft powerCON® Extension, 50 ft powerCON® Bare Wire Lead, 50 ft	19110372 19110373 19110374 19110375 19110376 19110377	PCEXT18IN PCEXT5FT PCEXT10FT PCEXT25FT PCEXT50FT PCLEAD50FT
MVP™ (Modular Video Panels) 2-pack and 6-pack (includes flight case, one signal, and one power cable per MVP™)	MVP 12 2-Pack MVP 12 6-Pack MVP 18 2-Pack MVP 18 6-Pack MVP 37.5 2-Pack MVP 37.5 6-Pack	12090346 12090347 12090348 12090349 12090350 12090351	MVP12x2 MVP12X6 MVP18x2 MVP18X6 MVP37.5x2 MVP37.5X6
MVP™ Media System and one MVP™ Driver	Rack mountable, video computer system with the MVP™ Driver and LED Studio software		MVPU-MS
MVP™ Media System with ArKaos Media Master Express + KN and One MVP™ Driver	Rack mountable, video computer system with the MVP™ Driver and LED Studio software, as well as ArKaos Media Master Express		MVPU-MSMME
ArKaos Media Master Express + KN	Video playback software + KN control		ARKAOSMMEKN

## About LED Studio

LED Studio is a powerful and easy-to-learn software application used to design and run the MVP™ Video Wall system. This application is used to play other programs and supports a range of formats (.txt, .doc, images, etc.), as well as video and audio files. Following is some introductory information about this software.

Refer to the **LED Studio User Manual** for detailed information and instructions on setting up and using LED Studio with your CHAUVET® MVP™ Video Wall system.

## Description

LED Studio enables you to create and control your MVP™ Video Wall display by addressing the panels included in your video wall and specifying and controlling video wall design.

Once you have physically created your modular video wall design by joining the panels, connecting power, signals, and the MVP™ Media System, you recreate that design within LED Studio. You then upload specific audio, video, text, and/or image files to display.

You use a Control Window to control the position, size and contents of what you create and upload. You use the Play Window to play back and review what you have created to display on your MVP™ Video Wall system.

Detailed information and instructions are in the **LED Studio User Manual** downloadable from the [www.chauvetlighting.com](http://www.chauvetlighting.com) website.



## 9. Technical Information

### MVP™ Maintenance

To maintain optimum performance and minimize wear, the user should clean this product regularly. Usage and environment are contributing factors in determining the cleaning frequency.

As a rule, clean this product at least twice a month. Dust build-up reduces light output performance and can cause overheating. This can lead to reduced light source life and increased mechanical wear.

To clean an MVP™, follow the recommendations below:

- Unplug the panel from power.
- Wait until the unit is cold.
- Use a soft brush to remove dust collected on the external components.
- Wipe the outside of the LED strips with a soft, lint-free cloth dampened with a solution of water and detergent. Apply gentle pressure only.
- Make sure all connections are thoroughly dry before reconnecting power and signal cables.



**Always dry the external surfaces carefully after cleaning them.**

### Troubleshooting Guide

Symptom	Cause(s)	Action(s)
All LEDs are blinking	Contact failure	Fix the loose LEDs or try re-plugging
LEDs on a specific circuit are not lit/working	Power output cable may be connected incorrectly Power cables may be plugged in reverse	Remove and connect correctly
All LEDs do not light	Output cables connected incorrectly	Find the incorrectly connected cables and reconnect properly
MVP™ does not power up (LED power indicator does not light during “self-test”)	No power Loose or damaged power cord Faulty power connection inside the MVP™ Faulty external power supply	Check for voltage on outlet Check power cord Send for repair
MVP™ displays no images or spotted images		Disconnect and reconnect the signal cable, or replace the cable



**If you still experience technical problems after trying the above solutions or if you need to send the unit for repair, contact [CHAUVET® Technical Support](#).**

## Returns Procedure

The user must send the merchandise prepaid, in the original box, and with its original packing and accessories. CHAUVET® will not issue call tags.

Call CHAUVET® and request a Return Merchandise Authorization (RMA) number before shipping the product. Be prepared to provide the model number, serial number, and a brief description of the cause(s) for the return.

The user must clearly label the package with an RMA number. CHAUVET® will refuse any product returned without an RMA number.



**DO NOT write the RMA number directly on the box. Instead, write it on a properly affixed label.**

Once you have received the RMA number please include the following information on a piece of paper inside the box:

- Your name
- Your address
- Your phone number
- The RMA number
- A brief description of the problem(s)

Be sure to pack the product properly. Any shipping damage resulting from inadequate packaging will be the customer's responsibility. Proper FedEx packing or double-boxing are recommended packaging methods.



**CHAUVET® reserves the right to use its own discretion to repair or replace returned product(s).**

## Contact Us

### World Headquarters

CHAUVET®

#### General Information

Address: 5200 NW 108<sup>th</sup> Avenue  
Sunrise, FL 33351  
Voice: 954-929-1115  
Fax: 954-929-5560  
Toll free: (800) 762-1084

#### Technical Support

Voice: 954-929-1115 (Press 4)  
Fax: 954-756-8015  
Email: tech@chauvetlighting.com

#### World Wide Web

[www.chauvetlighting.com](http://www.chauvetlighting.com)

### United Kingdom & Ireland

CHAUVET® Europe Ltd.

#### General Information

Address: Unit 1C  
Brookhill Road Industrial Estate  
Pinxton, Nottingham, UK  
NG16 6NT  
Voice: +44 (0)1773 511115  
Fax: +44 (0)1773 511110

#### Technical Support

Email: uktech@chauvetlighting.com

#### World Wide Web

[www.chauvetlighting.co.uk](http://www.chauvetlighting.co.uk)



## 10. Technical Specifications

	MVP™ 12	MVP™ 18	MVP™ 37.5
Light Source	Tri-color SMD LED	Tri-color SMD LED	Tri-color SMD LED
Pixels per Panel	48 x 48 (2,304 total)	32 x 32 (1,024 total)	16 x 16 (256 total)
Pixel Pitch (between panels)	12.5 mm	18.75 mm	37.5 mm
Pixel Density	6,400/m <sup>2</sup>	2,844/m <sup>2</sup>	711/m <sup>3</sup>
Display Refresh Rate	2,000 Hz (flicker-free)	2,000 Hz (flicker-free)	2,000 Hz (flicker-free)
Video Refresh Rate	60 Hz	60 Hz	60 Hz
Viewing Angle	140°	140°	140°
Luminance	3,500 NIT	3,100 NIT	1,200 NIT
Color Temperature	6500~9500 K	6500~9500 K	6500~9500 K
Color Wavelengths:			
Red	622~627 nm	622~627 nm	622~627 nm
Green	520~525 nm	520~525 nm	520~525 nm
Blue	465~470 nm	465~470 nm	465~470 nm
Power Supply Type	Switching	Switching	Switching
AC Voltage Range	100~240 VAC, 50/60 Hz	100~240 VAC, 50/60 Hz	100~240 VAC, 50/60 Hz
Voltage Selection	Auto-ranging	Auto-ranging	Auto-ranging
Power Consumption 120 V, 60 Hz	127 W; 1.1 A	120 W; 1.06 A	72 W; 0.6 A
Power Consumption 208 V, 60 Hz	139 W; 0.68 A	139 W; 0.68 A	78 W; 0.39 A
Power Consumption 230 V, 50 Hz	144 W; 0.63 A	144 W; 0.67 A	80 W; 0.36 A
Power Linking @ 120 V, 60 Hz	7 units	7 units	13 units
Power Linking @ 208 V, 60 Hz	11 units	11 units	20 units
Power Linking @ 230 V, 50 Hz	12 units	12 units	22 units
Dimensions	23.6 x 23.6 x 2.4 in (600 x 600 x 60 mm)	23.6 x 23.6 x 2.4 in (600 x 600 x 60 mm)	23.6 x 23.6 x 2.4 in (600 x 600 x 60 mm)
Weight	19.9 lbs (9 kg)	15.5 lbs (7 kg)	12.2 lbs (5.5 kg)
Transparency	13.4%	38%	60%
Mounting Design	Modular (horizontal & vertical)	Modular (horizontal & vertical)	Modular (horizontal & vertical)
Housing Material	Aluminum alloy	Aluminum alloy	Aluminum alloy
Power Connection	Neutrik® powerCON®	Neutrik® powerCON®	Neutrik® powerCON®
Control Connection	Neutrik® etherCON®	Neutrik® etherCON®	Neutrik® etherCON®

Shading indicates different specifications between MVP™ panels.



**CHAUVET®**  
5200 NW 108<sup>th</sup> Avenue  
Sunrise, FL 33351 (USA)  
(800) 762-1084 – 954-929-1115  
FAX 954-929-5560  
[www.chauvetlighting.com](http://www.chauvetlighting.com)

MVP™ (12/18/37.5) Series Getting Started User Manual, Rev. 10  
February 2012



*It's Green Thinking*