

# TFX-D12

## Stage Dimmer™ 12

### USER MANUAL

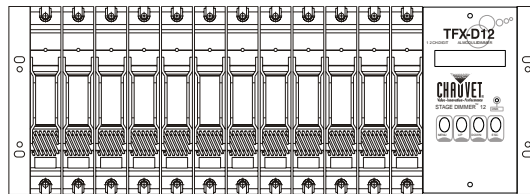

Chauvet, 3000 N 29<sup>th</sup> Ct, Hollywood, FL 33020 U.S.A  
(800) 762-1084 – (954) 929-1115  
FAX (954) 929-5560  
[www.chauvetlighting.com](http://www.chauvetlighting.com)

# TABLE OF CONTENT

<b>TABLE OF CONTENT</b> .....	<b>2</b>
<b>BEFORE YOU BEGIN</b> .....	<b>3</b>
WHAT IS INCLUDED .....	3
UNPACKING INSTRUCTIONS .....	3
WARNING .....	3
FEATURES .....	3
PRODUCT OVERVIEW .....	4
<b>INSTALLATION</b> .....	<b>5</b>
MOUNTING .....	5
POWER CONNECTIONS .....	6
<b>Input Power</b> .....	<b>6</b>
Single-phase.....	6
Three-phase.....	6
<b>Output Power</b> .....	<b>7</b>
<b>Control Wiring</b> .....	<b>7</b>
DMX512.....	7
Analog 0-10VDC.....	7
<b>OPERATING INSTRUCTIONS</b> .....	<b>8</b>
START MENU .....	8
MENU NAVIGATION .....	8
<b>Setup Menu</b> .....	<b>9</b>
<b>DMX Fail [Dmx fail]</b> .....	<b>9</b>
Hold, Analog.....	9
Prog.01-12.....	9
<b>Phase Correction [Pha corr]</b> .....	<b>10</b>
<b>DMX Address [Dmx addr]</b> .....	<b>10</b>
Block.....	10
Single.....	10
<b>Preheat [Preheat]</b> .....	<b>11</b>
All [All].....	11
Single Channel [Chan [1]].....	11
<b>Dimmer Curve [Curve]</b> .....	<b>11</b>
<b>Preset [Preset]</b> .....	<b>12</b>
All [All].....	12
Single Channel [Chan [1]].....	12
<b>APPENDIX</b> .....	<b>13</b>
DMX PRIMER .....	13
Fixture Linking.....	13
MAINTENANCE .....	14
RETURNS PROCEDURE .....	14
CLAIMS .....	14
TECHNICAL SPECIFICATIONS .....	15

# BEFORE YOU BEGIN

## What is included

- 1 x Stage Dimmer™ 12 (TFX-D12)
- Manual
- Warranty Card

## Unpacking Instructions

Immediately upon receiving a fixture, carefully unpack the carton, check the contents to ensure that all parts are present, and have been received in good condition. Notify the shipper immediately and retain packing material for inspection if any parts appear damaged from shipping or the carton itself shows signs of mishandling. Save the carton and all packing materials. In the event that a fixture must be returned to the factory, it is important that the fixture be returned in the original factory box and packing.

## Warning



Please read these instructions carefully, which includes important information about the installation, usage and maintenance?



- Please keep this User Guide for future consultation. If you sell the unit to another user, be sure that they also receive this instruction booklet.
- Always make sure that you are connecting to the proper voltage and that the line voltage you are connecting to is not higher than that stated on decal or rear panel of the fixture.
- This product is intended for indoor use only!
- To prevent risk of fire or shock, do not expose fixture to rain or moisture. Make sure there are no flammable materials close to the unit while operating.
- The unit must be installed in a location with adequate ventilation, at least 50cm from adjacent surfaces. Be sure that no ventilation slots are blocked.

***Because Dimmer packs operate at potentially lethal high voltages, installation wiring should be done by qualified persons only!***

***Do not connect chassis Ground to Neutral, or operate without chassis ground, otherwise the user could be exposed to potentially lethal voltages.***

## Features

- 12-channel DMX-512 dimmer/switch
- DMX-512 and Analog 0~10v DC control
- Each channel individually DMX addressable
- 12 built-in beat-activated programs (stand-alone)
- 10 Amp magnetic circuit breaker in each channel
- Individual dimmer modules
- LCD control panel is modular and can also be replaced
- Set preheat voltage to individual channel or all
- Dimmer curve selection; square, switch or linear
- AC phase correction
- Power failure memory
- Digital display and menu navigation buttons
- DMX signal loss failover function
- Thermal switch and short circuit protection
- Fan cooled

# Product Overview

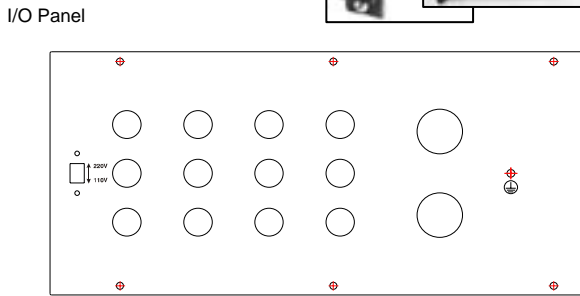
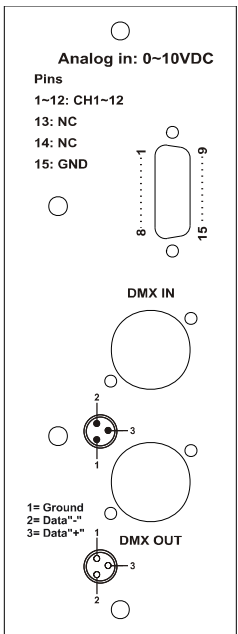
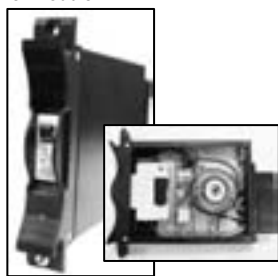
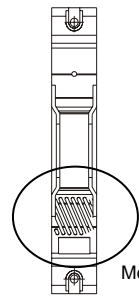
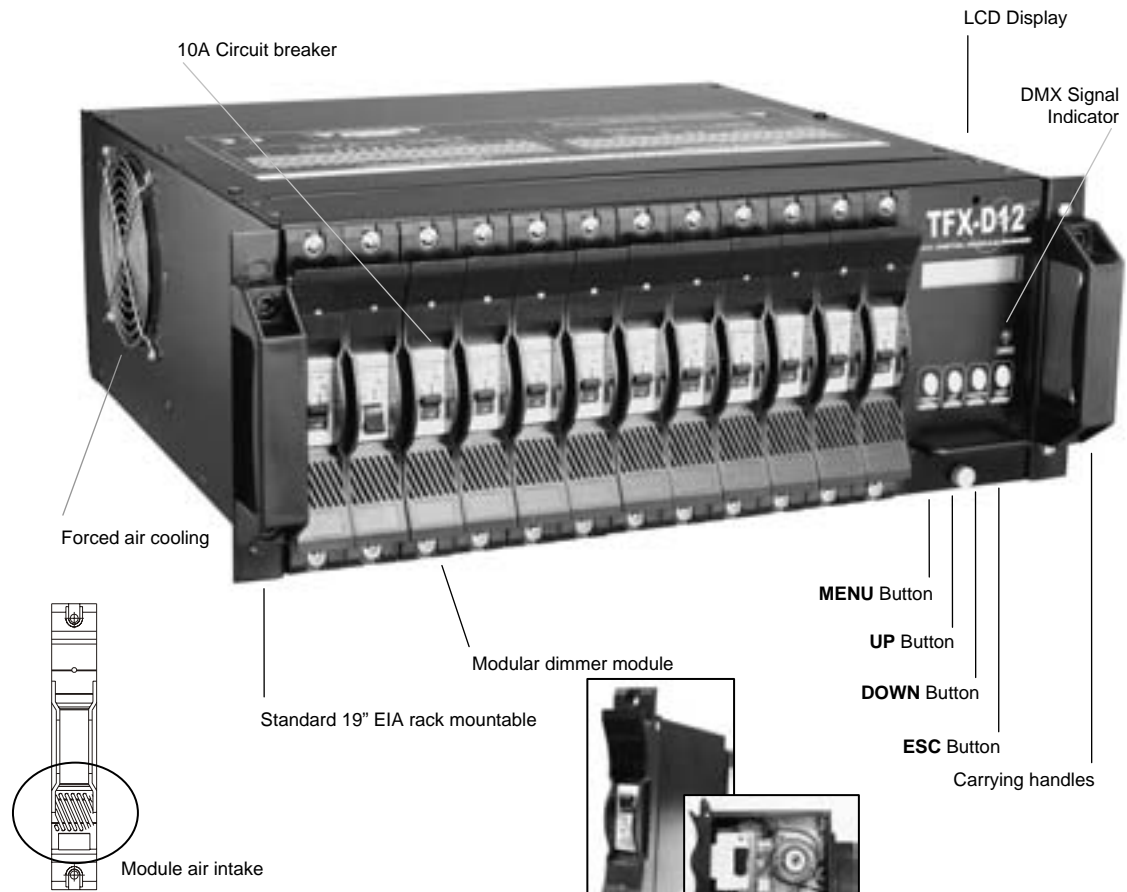

BUTTON	FUNCTION
<b>MENU</b>	Access the set-up and menu functions
<b>UP</b>	Scroll menu functions or increase values
<b>DOWN</b>	Scroll menu functions or decrease values
<b>ESC</b>	Go back one menu or leave menu system

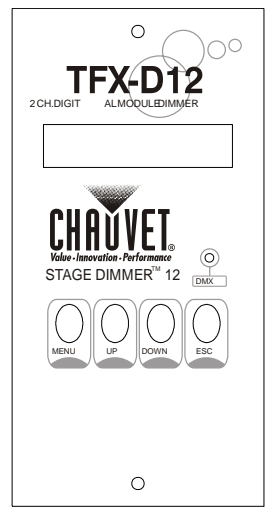

# INSTALLATION

## Mounting

The TFX-D12 dimmer packs are designed to be mounted in a standard 19" EIA rack using the two mounting holes on each flange/(ears). The two mounting flanges are designed for securing the dimmer pack to the front rack mounting rails. It is highly recommended that you add support to the rear of the dimmer pack, especially in touring or road case environments.

The TFX-D12 depends on forced air cooling and the following guidelines should be applied during installation:

1. The rack enclosure must maintain a 4 inch minimum clearance on the entire left side of the dimmer rack. The rack enclosure must not be sealed, and must maintain an air exhaust clearance area of at least 20 square inches per installed pack to allow air flow back to the ambient room.
2. The intake manifold on the front of the dimmer pack can never be blocked.
3. Ambient room temperature must never exceed 104°F/50°C

**Failure to adhere to proper and safe installation guidelines may result in a VOID of warranty!**

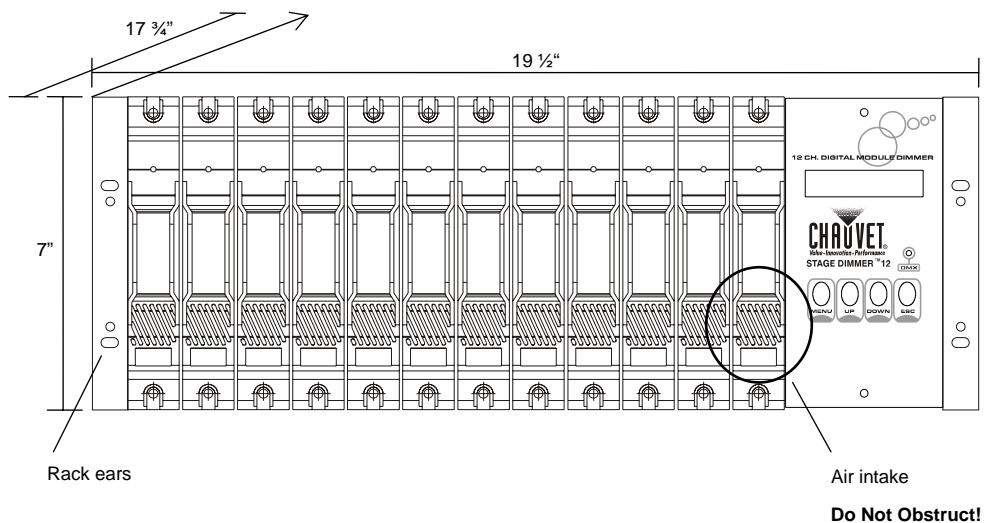

## Power Connections

**Warning! Make certain that power is removed from the circuits before you begin installation of the dimmer. Consult your local electrical codes to determine the proper wire type and wiring methods for your regional installation.**

### Input Power

#### SINGLE-PHASE

1 phase, 3 wire 120/240 VAC, 120 Amps, 50~60Hz

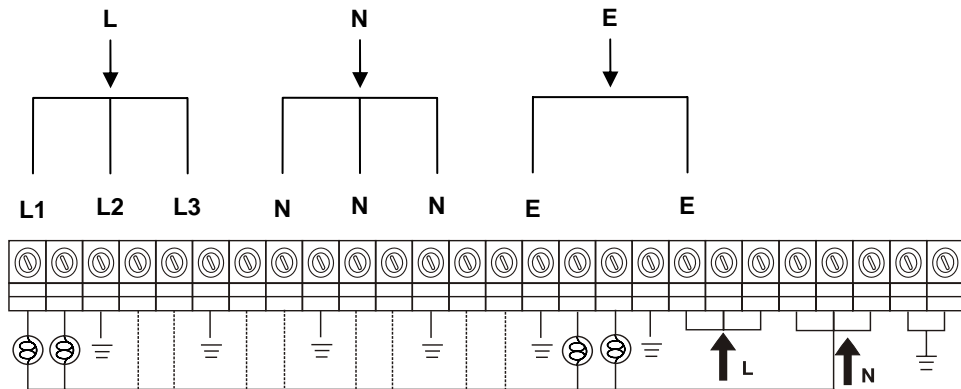

POWER INPUT: - - - - - AC 120V/230V~50/60Hz  
 OUTPUT: - - - - - 10A per channel, Total 120A

#### THREE-PHASE

3 phase, 4 wire 120/240 VAC, 40 Amps, 50~60Hz

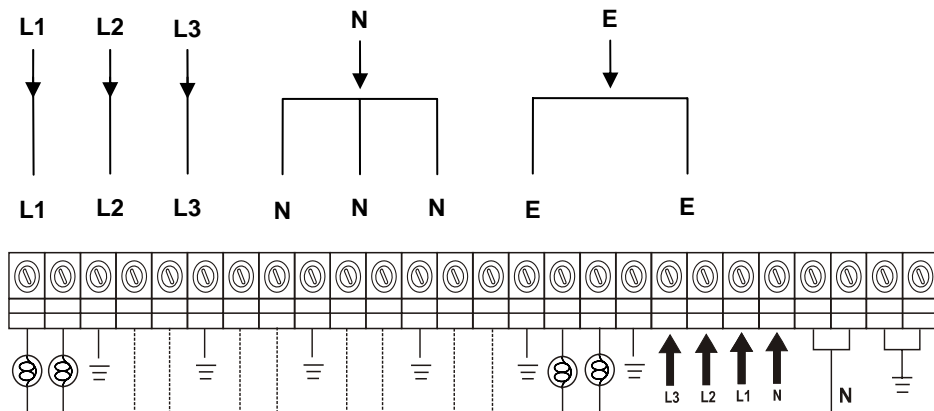

POWER INPUT: - - - - - AC 120V/230V~50/60Hz  
 OUTPUT: 10A per channel, Total 40A per phase

## Output Power

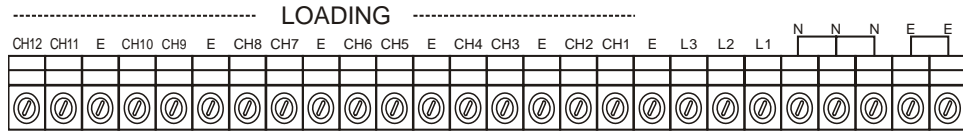

## Control Wiring

### DMX512

Input: 3-pin XLR (male)

Output: 3-pin XLR (female)

Pin	Signal
1	DGND
2	DATA (-)
3	DATA (+)

### ANALOG 0-10VDC

Input: 15-pin M D-Sub

Pin	Signal
1	Channel 1
2	Channel 2
3	Channel 3
4	Channel 4
5	Channel 5
6	Channel 6
7	Channel 7
8	Channel 8
9	Channel 9
10	Channel 10
11	Channel 11
12	Channel 12
13	NC
14	NC
15	Ground

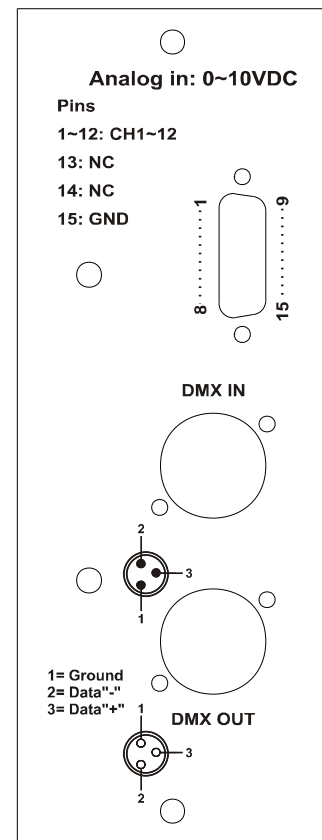

# OPERATING INSTRUCTIONS

## Start Menu

Upon powering the dimmer, the LCD panel will display the software version presently installed and shortly after, will enter standby mode.

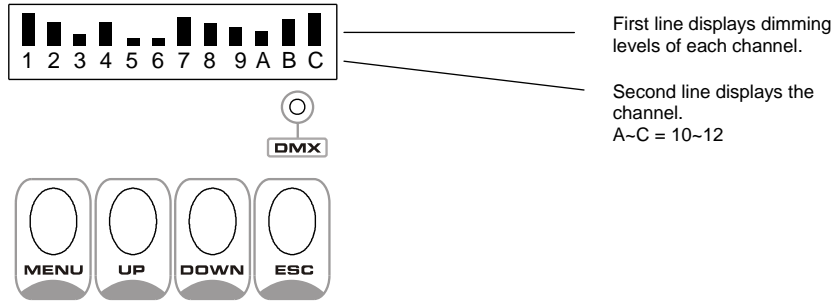

## Menu Navigation

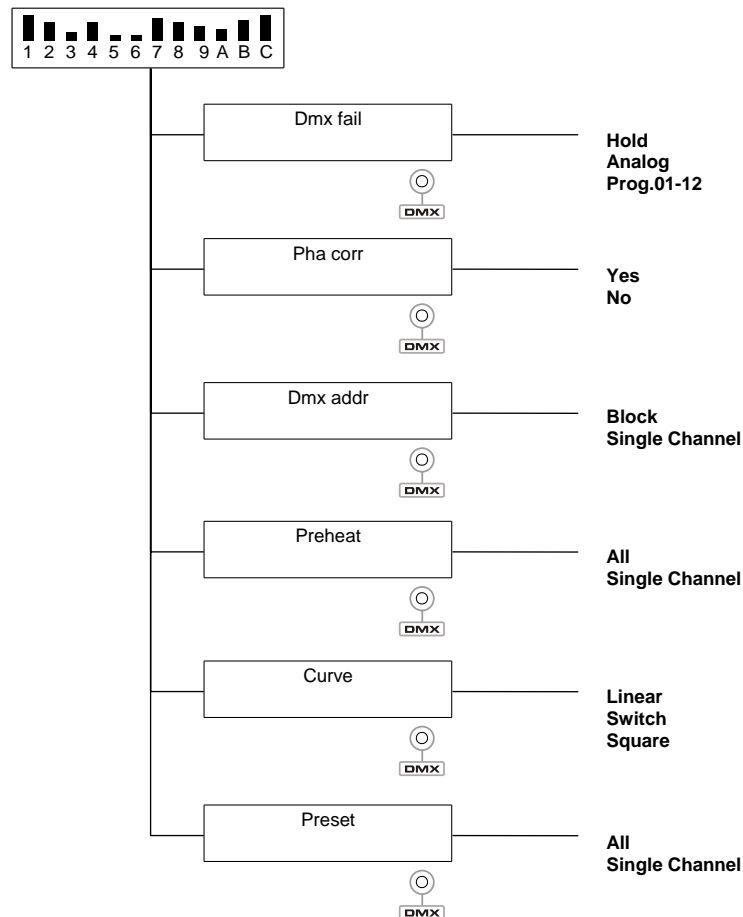



## Setup Menu

### Action

- 1) Press the **MENU** button to enter the setup menu.
- 2) There are 6 menu items to choose from; Dmx fail, Phase Correction, Dmx addr, Preheat, Curve and Preset.
- 3) Press the **UP** and **DOWN** buttons to scroll menu items.
- 4) Press **ESC** to exit the setup menu.

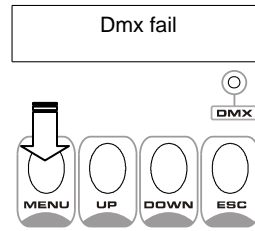

## DMX Fail [Dmx fail]

The DMX Fail feature allows the user to select how the dimmer will behave if you were to loose the DMX controller's signal to the dimmer.

### Action

- 1) Press the **MENU** button to enter the setup menu.
- 2) Press the **UP** and **DOWN** buttons to scroll menu items until you reach [**Dmx fail**].
- 3) Press **MENU** to enter the sub-menu.
- 4) If it were running the built-in scene 08 it would display as per the illustration on the right.
- 5) Press the **UP/DOWN** buttons to select one of the following; [**Hold**], [**Analog**], [**Prog.01-12**].

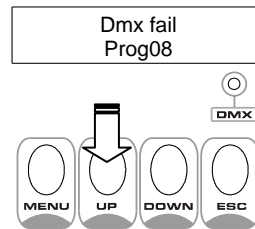

**Hold** – The dimmer will hold the last dmx signal received.

**Analog** – The dimmer will revert to the Analog input signal.

**ProgXX** - Will start internal programs 1-12.

## HOLD, ANALOG

- 1) Whether you choose **Hold** or **Analog** press the **ESC** button to confirm and exit.

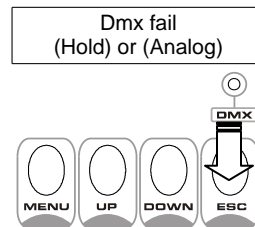

## PROG.01-12

- 1) Press the **ESC** button to confirm.
- 2) Select a chasing speed from 0.1 to 20 seconds using the **UP/DOWN** button. (Hold the UP/DOWN buttons for two seconds to change speed quickly.)
- 3) Press the **ESC** button to confirm setting.

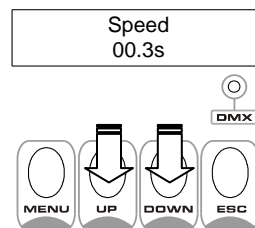

### Phase Correction [Pha corr]

**Action** 

- 1) Press the **MENU** button to enter the setup menu.
- 2) Press the **UP/DOWN** buttons until you reach **[Pha corr]**.
- 3) Press **MENU** to enter the sub-menu.
- 4) Press **UP/DOWN** buttons to choose between Yes and No.
- 5) Press **ESC** button to activate.

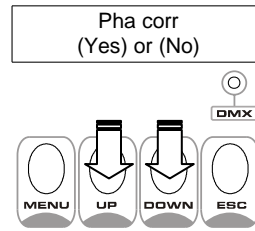

### DMX Address [Dmx addr]

**Action** 

- 1) Press the **MENU** button to enter the setup menu.
- 2) Press **UP/DOWN** buttons to choose between **[Block]** and **[Single]** configuration.
- 3) Press **MENU** button to enter the sub-menu.

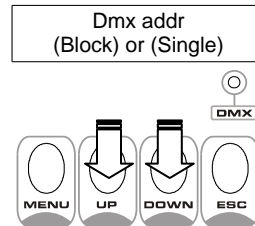

**Block** – Block addressing refers to 12 consecutive channels using only one starting address.

**Single** – Allows the user to select a starting address for each channel.

#### BLOCK

- 1) Press the **ESC** button to confirm.
- 2) Press **UP/DOWN** buttons to select the start address between 001 and 512.

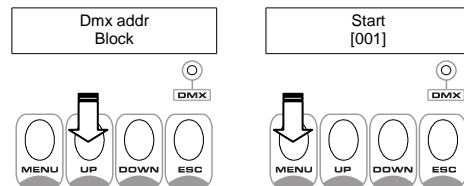

#### SINGLE

- 1) In **[Chan[1]]**/Single Channel mode press **MENU** to change between the channel and its' start address as noted by the cursor.
- 2) In **[Chan]**, press **UP/DOWN** buttons to select channels 1~12. In **[001]**, press **UP/DOWN** buttons to select dmx start address [001-512].
- 3) Press the **ESC** button to exit and confirm.

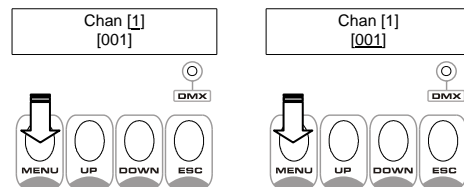

## Preheat [Preheat]

### Action

- 1) Press the **MENU** button to enter the setup menu.
- 2) Press the **UP** and **DOWN** buttons to scroll menu items until you reach **[Preheat]**.
- 3) Press **MENU** button to enter the sub-menu.
- 4) Press the **UP/DOWN** buttons to choose between **[All]** and **[Chan]**/Single Channel mode.
- 5) Press **MENU** to select mode.

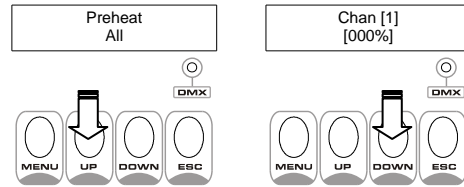

### ALL [All]

- 1) Press **UP/DOWN** to select the preheat value between [000%] – [050%] for all channels.

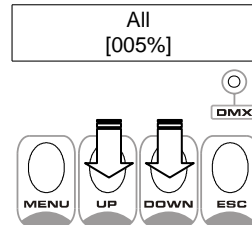

### SINGLE CHANNEL [Chan [1]]

- 1) In **[Chan [1]]**/Single Channel mode press **MENU** to change between the channel and its' start address as noted by the cursor.
- 2) In **[Chan]**, press **UP/DOWN** buttons to select channels 1~12. In **[001]**, press **UP/DOWN** buttons to select percentage [000%-050%].
- 3) Press the **ESC** button to exit and confirm.

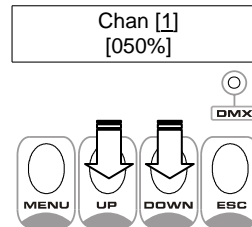

## Dimmer Curve [Curve]

### Action

- 1) Press the **MENU** button to enter the setup menu.
- 2) Press the **UP** and **DOWN** buttons to scroll menu items until you reach **[Curve]**.
- 3) Press the **MENU** button to enter the sub-menu.
- 4) Press **UP/DOWN** buttons to select from **Linear, Switch & Square** dimmer curve.
- 5) Press **ESC** button to exit and confirm.

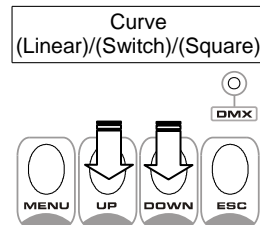

## Preset [Preset]

### Action

- 1) Press the **MENU** button to enter the setup menu.
- 2) Press the **UP** and **DOWN** buttons to scroll menu items until you reach **[Preset]**.
- 3) Press the **MENU** button to enter the sub-menu.
- 4) Press **UP/DOWN** buttons to select between All/Single Channel mode.

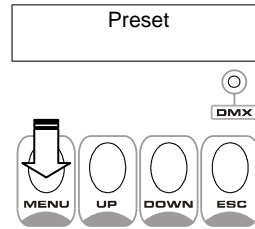

## ALL [All]

- 1) Press **UP/DOWN** to select the master dimmer level value between [000%] – [100%] for all channels.

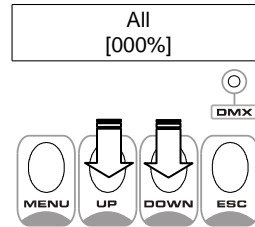

## SINGLE CHANNEL [Chan [1]]

- 1) In **[Chan [1]]**/Single Channel mode press **MENU** to change between the channel and its' start address as noted by a cursor.
- 2) In **[Chan]**, press **UP/DOWN** buttons to select channels 1~12. In **[001]**, press **UP/DOWN** buttons to select percentage [000%-1\*0%].
- 3) Press the **ESC** button to exit and confirm.

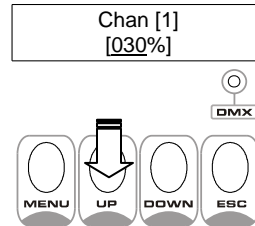

# APPENDIX

## DMX Primer

There are 512 channels in a DMX-512 connection. Channels may be assigned in any manner. A fixture capable of receiving DMX 512 will require one or a number of sequential channels. The user must assign a starting address on the fixture that indicates the first channel reserved in the controller. There are many different types of DMX controllable fixtures and they all may vary in the total number of channels required. Choosing a start address should be planned in advance. Channels should never overlap. If they do, this will result in erratic operation of the fixtures whose starting address is set incorrectly. You can however, control multiple fixtures of the same type using the same starting address as long as the intended result is that of unison movement or operation. In other words, the fixtures will be slaved together and all respond exactly the same.

DMX fixtures are designed to receive data through a serial Daisy Chain. A Daisy Chain connection is where the DATA OUT of one fixture connects to the DATA IN of the next fixture. The order in which the fixtures are connected is not important and has no effect on how a controller communicates to each fixture. Use an order that provides for the easiest and most direct cabling. Connect fixtures using shielded two conductor twisted pair cable with three pin XLR male to female connectors. The shield connection is pin 1, while pin 2 is Data Negative (S-) and pin 3 is Data positive (S+). CHAUVET carries 3-pin XLR DMX compliant cables, DMX-10 (33'), DMX-4.5 (15') and DMX-1.5 (5')

## FIXTURE LINKING

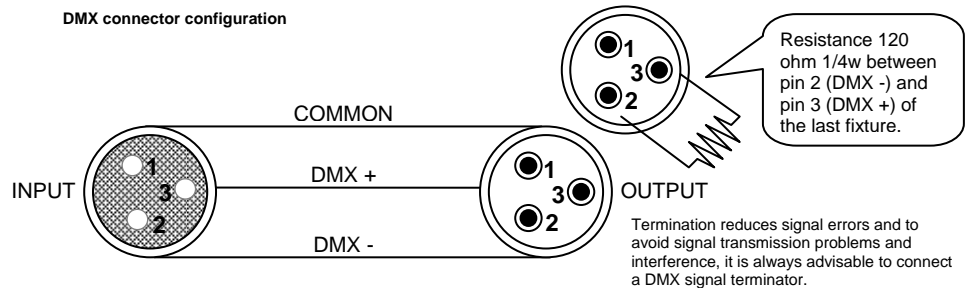

**Note!**

**If you use a controller with a 5 pin DMX output connector, you will need to use a 5 pin to 3 pin adapter. CHAUVET Model No: DMX5M. The chart below details a proper cable conversion:**

### 3 PIN TO 5 PIN CONVERSION CHART

CONDUCTOR	3 Pin Female (output)	5 Pin Male (Input)
GROUND/SHIELD	Pin 1	Pin 1
DATA ( - ) SIGNAL	Pin 2	Pin 2
DATA ( + ) SIGNAL	Pin 3	Pin 3
DO NOT USE		Do not use
DO NOT USE		Do not use

## Maintenance

To maintain optimum performance and minimize wear fixtures should be cleaned frequently. Usage and environment are contributing factors in determining frequency. As a general rule, fixtures should be cleaned at least twice a month. Dust build can cause overheating. Be sure to power off fixture before conducting maintenance.

Unplug fixture from power. Use a vacuum or air compressor and a soft brush to remove dust collected on external vents and internal components.

## Returns Procedure

Returned merchandise must be sent prepaid and in the original packing, call tags will not be issued. Package must be clearly labeled with a Return Merchandise Authorization Number (RA #). Products returned without an RA # will be refused. Call CHAUVET and request RA # prior to shipping the fixture. Be prepared to provide the model number, serial number and a brief description of the cause for the return. Be sure to properly pack fixture, any shipping damage resulting from inadequate packaging is the customer's responsibility. CHAUVET reserves the right to use its own discretion to repair or replace product(s). As a suggestion, proper UPS packing or double-boxing is always a safe method to use.

## Claims

Damage incurred in shipping is the responsibility of the shipper; therefore the damage must be reported to the carrier upon receipt of merchandise. It is the customer's responsibility to notify and submit claims with the shipper in the event that a fixture is damaged due to shipping. Any other claim for items such as missing component/part, damage not related to shipping, and concealed damage, must be made within seven (7) days of receiving merchandise.

## Technical Specifications

### WEIGHT & DIMENSIONS

Length.....	451 mm (17.75 in)
Width .....	495 mm (19.5 in)
Height.....	178 mm (7 in)
Weight .....	27 Kg (59.5 lbs)

### INPUT POWER

Switch-selectable power setting (on-board PCB).....	115V 60 Hz or 230V 50 Hz
Single-phase input.....	3 wire + GD, 120/230 VAC, 120 Amps, 50-60Hz
Three-phase input .....	4 wire + GD, 120/230 VAC, 120 Amps, 50-60Hz

### OUTPUT CAPACITY

120VAC, 12-channels .....	1200 Watts per channel @ 120VAC
230VAC, 12-channels .....	2300 Watts per channel @ 230VAC

### OUTPUT PANEL

.....	Hard-wired terminal blocks
-------	----------------------------

### OVERLOAD PROTECTION

.....	10 Amp Fast Acting Circuit Breakers per Channel
-------	---

### CONTROL & PROGRAMMING

Data input .....	locking 3-pin XLR male socket
Data output .....	locking 3-pin XLR female socket
Data pin configuration .....	pin 1 shield, pin 2 (-), pin 3 (+)
Protocols.....	DMX-512 USITT
DMX Channels .....	12
Analog .....	12 channels of 0-10VDC

### ORDERING INFORMATION

Stage Dimmer™ 12.....	TFX-D12
-----------------------	---------