

# Exterior 200

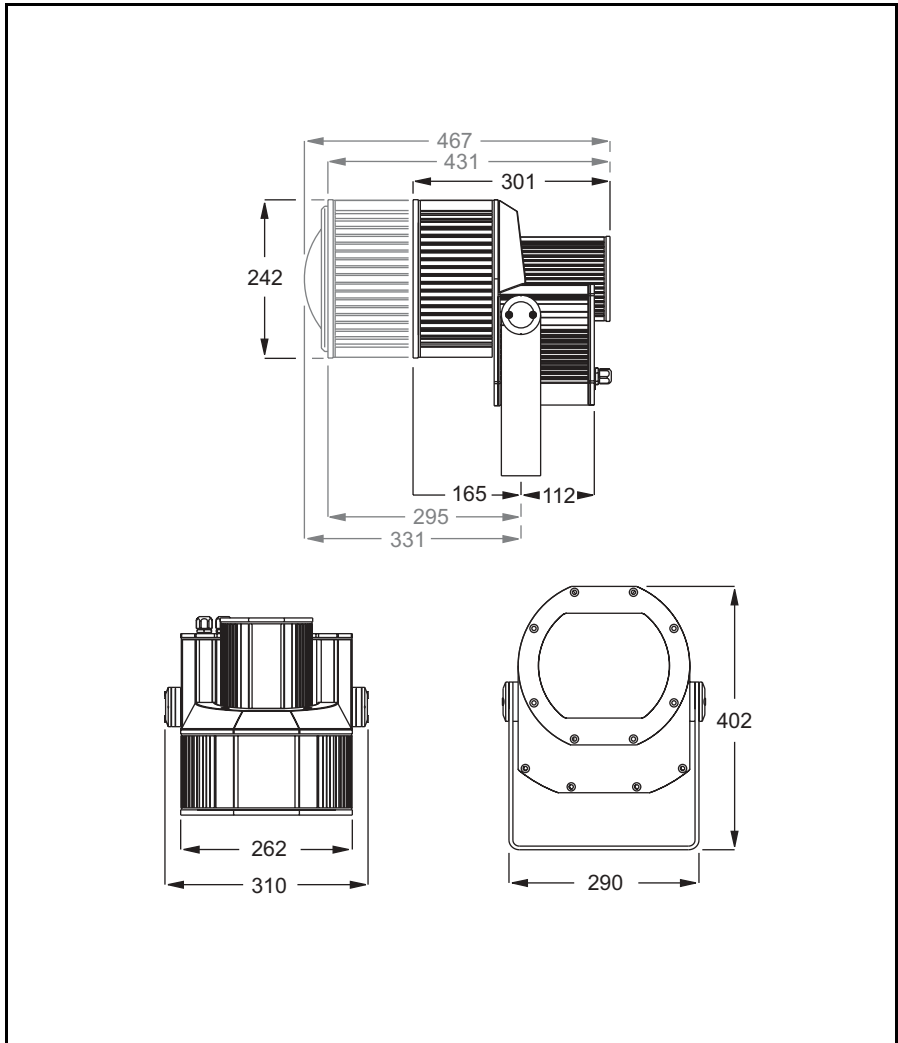

user manual

Measurements are in millimeters



© 2003-2005 Martin Professional A/S, Denmark.

All rights reserved. No part of this manual may be reproduced, in any form or by any means, without permission in writing from Martin Professional A/S, Denmark.

Printed in Denmark.

P/N 35000096, Rev G

# **SECTION 1. GETTING STARTED 5**

## **INTRODUCTION 6**

- Software note 7
- Safety information 7

## **INSTALLATION 9**

- Unpacking 9
- Fastening method 9
- Fixture orientation and location 10
- Bracket adjustment 11
- AC power 11
- Data link 15

## **FIXTURE SETTINGS 17**

- Defining fixture settings using MUM 18
- Defining fixture settings using an MP-2 21

## **GENERAL OPERATION 25**

- General guidelines 25
- The LEDs and fixture operating status 25
- Fixture control methods 26

# **SECTION 2. STAND-ALONE OPERATION 27**

## **STAND-ALONE PROGRAMMING OVERVIEW 28**

- About scene timing 29
- Synchronizing scene changes for multiple Exterior 200s 29
- Programming methods 30

## **PROGRAMMING FROM A PC USING MUM 31**

- Getting started 31
- Stand-Alone Settings 32
- Programming effects in scenes 34
- Programming the same stand-alone show on multiple fixtures 36

## **PROGRAMMING USING AN MP-2 UPLOADER 37**

- Getting started 37
- Selecting fixtures to program 38
- Enabling or disabling stand-alone mode 39
- Synchronizing scene changes for multiple Exterior 200s 39
- Automatically triggering stand-alone operation 40
- Programming effects in scenes 42
- Automatic program start at power-on 43
- Disconnecting the MP-2 Uploader 43

## **STAND-ALONE SHOW PLAYBACK 44**

Starting show playback automatically at fixture power-on 44

Scene execution using the optional MC-X 44

DMX controller override during stand-alone show playback 45

## **SYNCHRONOUS TRIGGERING DURING STAND-ALONE OPERATION 46**

## **SECTION 3. DMX CONTROL 49**

### **DMX CONTROLLER OPERATION 50**

Lamp control 50

Effects 51

## **SECTION 4. OPTICS 53**

### **COLOR MATCHING EXTERIOR 200s AND 600s 54**

### **LENS OPTIONS 55**

Changing the lens 55

## **SECTION 5. SERVICE AND TROUBLESHOOTING 57**

### **SERVICE 58**

Seal maintenance 58

Lamp replacement 59

Cleaning 60

Firmware updates 60

Fuse replacement 61

### **PRINTED CIRCUIT BOARD LAYOUT 62**

### **TROUBLESHOOTING 63**

## **SECTION 6. REFERENCE 65**

### **MP-2 CONTROL MENU STRUCTURE 66**

### **DMX PROTOCOL 69**

### **SPECIFICATIONS - EXTERIOR 200 70**

# **SECTION 1. GETTING STARTED**

# Introduction

Thank you for selecting the Martin Exterior 200. The Exterior 200 is an automated 150 watt color-changing floodlight designed for fixed exterior installation. It features seamless cyan, magenta, yellow (CMY) color mixing and full-range continuous dimming. The fixture may be operated with DMX controllers or in stand-alone mode with programmable start and stop times or light levels.

An Exterior 200 running a pre-programmed show can perform synchronized scene changes with up to 31 other Martin fixtures of the following types:

- Exterior 200
- Exterior 600
- FiberSource CMY150
- Imager series
- Alien 02 series
- MiniMAC Maestro

## Exterior 200 models

The Exterior 200 is available in three models:

<b>Beam angle:</b>	<b>Configured for local supplies:</b>
60°	230V/50Hz, 245V/50Hz, or 210V/60Hz

## Exterior 200 Long Barrel models

The Exterior 200 Long Barrel is available in six models:

<b>Beam angle:</b>	<b>Configured for local supplies:</b>
12°	230V, 50Hz, 245V/50Hz, or 210V/60Hz
22°	230V/50Hz, 245V/50Hz, or 210V/60Hz

## Optional beam angles

The following optional lens are available for Exterior 200 models:

- Fresnel lens (provides a 34° beam angle in a standard Exterior 200)
- Micro diffuser lens (provides a 71° beam angle in a standard Exterior 200)
- Beam shaper (provides a 83° x 91° beam angle in a standard Exterior 200 and a 14° x 69° beam angle in an Exterior 200 Long Barrel)

## Software note

---

The functions described in this manual are valid from Version 2 of the Exterior 200 software. When running earlier versions of the software you can refer to an earlier revision of this user manual. These are available from <http://www.martin.com>.

## Safety information

---

**Warning!** *This product is not for household use.*

This product presents risks of lethal or severe injury due to fire and heat, electric shock, ultraviolet radiation, lamp explosion, and falls. **Read this manual** before powering or installing the fixture, follow the safety precautions listed below and observe all warnings in this manual and on the fixture. If you have questions about how to operate the fixture safely, please contact your Martin dealer or call the Martin 24-hour service hotline at +45 70 200 201.

### Guarding against electric shock

- Disconnect the fixture from AC power before removing or installing the lamp, fuses, or any part.
- Always ground (earth) the fixture electrically.
- Use only a source of AC power that complies with local building and electrical codes and has both overload and ground-fault protection.
- Refer all service to a Martin service technician.

### Preventing UV radiation and lamp explosion

- Never operate the fixture with missing or damaged lenses and/or covers.
- When replacing the lamp, allow the fixture to cool for at least 15 minutes before opening the fixture.
- Do not stare directly into the light. Never look at an exposed lamp while it is lit.
- Replace the lamp if it becomes defective or worn out.

### Guarding against burns and fire

- Never attempt to bypass the thermostatic switch or fuses. Always replace defective fuses with ones of the specified type and rating.

- Keep all combustible materials (for example fabric, wood, paper) at least 1 meter (39 inches) away from the fixture. Keep flammable materials well away from the fixture.
- Do not illuminate surfaces within 0.5 meters (20 inches) of the fixture.
- Install the fixture outdoors or in a well ventilated area.
- Never place filters or other materials over the lens.
- The exterior of the fixture becomes very hot, up to 90° C (194° F) during normal operation. Do not locate the fixture in areas where accidental contact is likely.
- Do not modify the fixture or install other than genuine Martin parts.
- Do not operate the fixture if the ambient temperature ( $T_a$ ) exceeds 40° C (104° F).

## **Preventing injury due to falls**

- When suspending the fixture above ground level, verify that the structure is able to support the weight of all installed devices and hardware.
- Block access below the work area whenever installing or removing the fixture.



# Installation

This section describes in general terms how to mount the fixture and connect it to data and AC power. These procedures shall be performed by qualified professionals.

## Unpacking

---

The Exterior 200 comes with the following items:

- Philips CDM-SA/T 150 W discharge lamp (installed)
- User manual

## Fastening method

---

**Notice!** *It is the installer's responsibility to determine the anchoring method.*

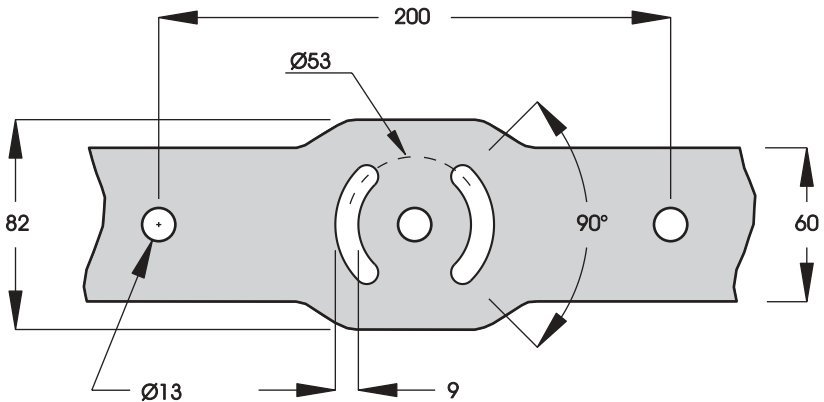

The Exterior 200 may be permanently fastened to any flat surface, pedestal, or other support that can safely bear the weight of all installed fixtures and hardware.

The mounting bracket provides 3 holes for 12 mm (1/2 in.) hardware, spaced 100 mm on center, and 2 quarter-circle slots with a center radius of 26.5 mm for 8 mm (5/16 in.) hardware.

Consult a qualified engineer to determine a suitable anchoring method. The specific fastening hardware will depend on the installation. In general, use high quality metric grade 8.8 or better corrosion resistant screws such as zinc-plated steel, and self-locking nuts or lock-washers to secure the fixture.

## Fixture orientation and location

---

When choosing a location for the fixture, consider that it has an ingress protection rating of 65. This means that the fixture is totally dust proof and that it is protected from water ingress to the level that moisture from low-pressure water jets from any direction cannot get into the product. However, the product is not designed to withstand:

- High-pressure water jets from any direction
- Immersion in water (or any other fluid)

Do not bury the Exterior 200 or otherwise locate it in an unventilated space. Install the fixture in a location where it is

- at least 0.5 meters (20 inches) away from the surface to be illuminated,
- at least 1 meter away from any combustible materials, and
- away from accidental public contact.

If the fixture points down, it must be installed with the power section over the lamp section as shown so that water cannot collect between the lamp section and the power section.

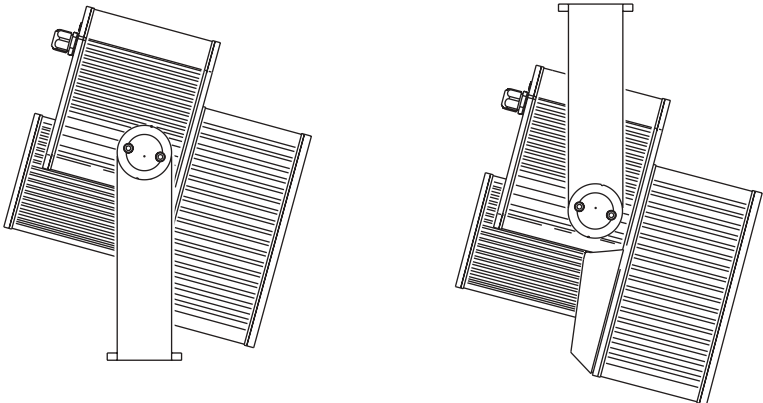

*When the fixture is located above the area to be illuminated, install with the power section on top.*

## Bracket adjustment

---

The mounting bracket can be positioned along the length of the power section and pivots  $+70/-210$  degrees from the 6 o'clock position shown inside front cover.

This procedure requires 4 mm and 5 mm Allen wrenches (hex keys).

**Warning!** *Allow the fixture to cool before handling.*

To adjust the mounting bracket:

- 1 To adjust the bracket's lateral position, remove the outer discs on each side of the bracket. Loosen, but do not remove, the bracket screws. Slide the fixture to the desired position and retighten the bracket screws. Replace the outer discs.
- 2 To adjust the tilt angle, loosen the tilt-lock screws. Turn the fixture to the desired angle and retighten the screws.

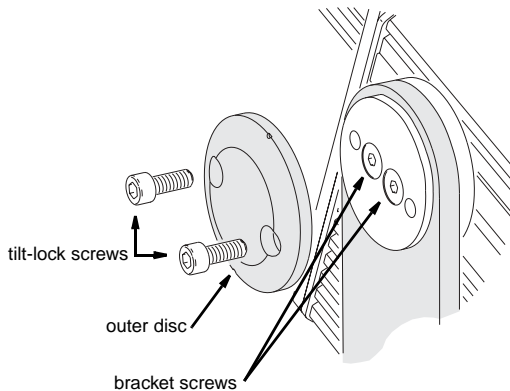

## AC power

---

Do not connect the Exterior 200 to an electrical dimmer system: doing so can damage the electronics.

**Warning!** *Disconnect the fixture from AC power before removing any cover.*

**Important!** *Verify voltage and frequency settings before applying power.*

## Power supply settings

Your Exterior 200 is factory-wired to one of the configurations shown in Table 1. The factory settings are printed on the serial number label. If your local AC voltage or frequency differ from the settings for your model, the fixture's power supply must be rewired by a qualified installer or technician.

<b>Voltage</b>	<b>Frequency</b>
230 V	50 Hz
245 V	50 Hz
210 V	60 Hz

**Table 1: Default Power Supply Settings**

### Changing the power supply settings

- 1 Verify that the Exterior 200 is isolated from AC power. Remove the rear cover.

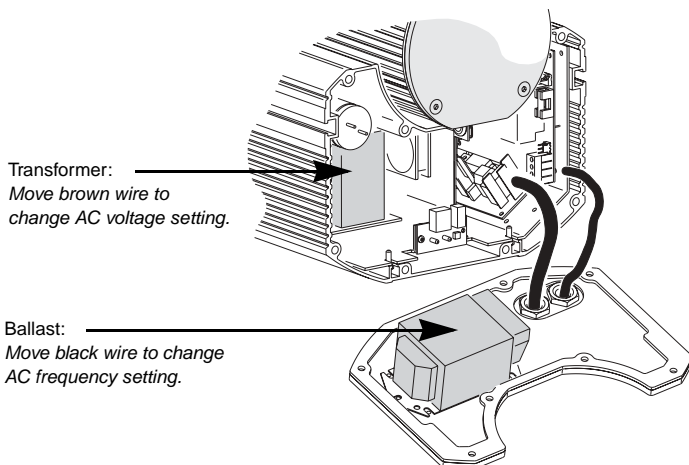

- 2 Find the correct transformer setting for the local AC voltage in Table 2. Move the brown transformer wire to the tap listed for the setting.

AC Mains voltage	Transformer setting	Tap, brown wire	Tap, white & blue wires	Tap, black wire
190 - 202 V	195 V	11	9	14
203 - 217 V	210 V	12		
218 - 235 V	225 V	14		
236 - 252 V	245 V	15		
269 - 285 V	277 V	16		

**Table 2: Transformer Primary Taps**

- Set the correct AC frequency on the ballast (located on the back of the rear cover) by moving the black ballast wire to the 50 or 60 Hz terminal. (To release the wire, insert a screwdriver in the hole next to the terminal.) Make sure the wire is securely connected.
- Replace the rear cover before applying power. See “Gaskets” on page 58.

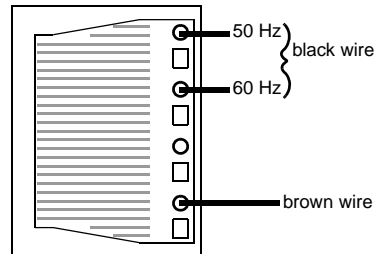

To set the frequency, move the black wire to the 50 or 60 Hz terminal.

## Mains connection

**Warning!** For protection from dangerous electric shock, the fixture must be grounded (earthed). The AC mains supply shall be fitted with a fuse or circuit breaker, ground-fault protection, and a means to isolate the fixture from the mains during service or when not in use.

*The fixture is supplied with a weatherproof power cable. However, note that if there is a breach or cut at any point along the power cable (for example at a connection point), and if this is exposed to water, moisture can be drawn up the inside of the cables due to the vacuum effect from the heat generated during operation. When installing the product outdoors, always ensure that the fixture is protected from water ingress from inside its power cable by:*

- Protecting the connectors on the power cables in a weatherproof housing, or a weatherproof electrical junction box, or
- Using IP65 rated cord caps, or

- **Replacing the supplied cable with one that connects directly inside the fixture.**

The Exterior 200 is equipped with a 1.8-meter (5.9 ft.) length of 3-conductor 0.75 mm<sup>2</sup> (~18 AWG) weatherproof electrical cable for connection to the AC power supply. The cable enters the fixture through a cable gland that fits 5.5 - 10 mm diameter cables. The cable attaches with 1/4" female spade plugs on the live and neutral wires and a ring terminal on the ground wire.

## Replacing the mains lead

Other cable can be installed as follows.

- 1 Isolate the fixture from AC power.
- 2 Loosen both cable gland cap nuts and remove the power section cover. Disconnect the existing mains cable and pull it through the cable gland.
- 3 Pass the new cable through the cable gland and connect the leads. The live wire connects to PL3, the neutral wire connects to PL1, and the ground wire connects to the chassis screw terminal.
- 4 Draw up the slack in the AC and data cables and replace the power section cover. Tighten the cable gland cap nuts well to seal against moisture.

## Installing a cord cap on the mains lead

A non-IP-rated cord cap may be installed on the mains lead for testing, service, and temporary applications. For outdoor installations an IP65-rated cord cap can be used.

Following the cord cap manufacturer's instructions, connect the yellow and green wire to ground (earth), the brown wire to live, and the blue wire to neutral. Table 3 shows some pin identification schemes; consult an electrician if you have any doubts about proper installation.

Wire (EU)	Wire (US)	Pin	Marking	Screw (US)
brown	black	live	"L"	yellow or brass
blue	white	neutral	"N"	silver
yellow/green	green	ground		green

**Table 3: Cord Cap Connections**

# Data link

---

A data link is required for DMX controller operation, and for synchronized stand-alone operation of multiple Exterior 200s.

## Cable and junctions

The Exterior 200 provides a dual 1.8 meter (5.9 ft.) 24 AWG cable with locking 3-pin male and female XLR connectors for data connection. The male cable is the data input and the female cable is the data output. The connectors are wired pin 1 to shield (gnd.), pin 2 to signal - (cold), and pin 3 to signal + (hot).

Use RS-485 data cable designed for outdoor use to extend the link. RS-485 cable has low capacitance and a characteristic impedance of 85 to 150 ohms. It is electrically shielded and has at least 1 twisted-pair of conductors. The minimum wire size is 0.2 mm<sup>2</sup> (24 AWG) for runs up to 300 meters (1000 ft.) and 0.35 mm<sup>2</sup> (22 AWG) for runs up to 500 meters (1640 ft.).

**Warning!** *The fixture is not supplied with a weatherproof XLR connectors. If these connectors are exposed to water, moisture can be drawn up the inside of the cables due to the vacuum effect from the heat generated during operation. When installing the product outdoors, always ensure that the fixture is protected from water ingress from inside its data cable by:*

- *Protecting the connectors on the data cable in a weatherproof housing (or a weatherproof electrical junction box), or*
- *Using IP65 rated XLR cable and connectors (such as those produced by Neutrik), or*
- *Replacing the supplied cable with one that connects directly inside the fixture. This option requires a new cable gland, see “Cable glands” on page 58. The leads connect to the main circuit board as shown to right.*

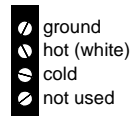

PCB data connections

## Adaptors

Adaptors may be required to connect the Exterior 200 to the controller or other 5-pin devices. Adaptor cables for indoor use are available from Martin. The adaptor cables are wired as shown below.

5-pin to 3-pin Adaptor		3-pin to 5-pin Adaptor	
Male	Female	Male	Female
1	1	1	1
2	2	2	2
3	3	3	3
4			4
5			5
P/N 11820005		P/N 11820004	

## Splitter/Amplifiers

A device such as the Martin 4-Channel Opto-Isolated RS-485 Splitter/Amplifier may be used to branch the data link and/or extend its length. Do not use a “Y” connector to split the link.

## Terminators

Termination of the data link is required for trouble-free communication. For temporary installations, this can be achieved with a male termination plug inserted into the data output cable of the last fixture in each chain. A termination plug is simply an XLR connector with a 120 ohm resistor soldered across pins 2 and 3.

For permanent terminations, the link can be terminated with a 120 ohm resistor across the hot and cold data terminals at the main circuit board inside the last fixture in each chain.

## Building a data link

To build a data link:

- 1 Connect a data cable to the controller's data output. A male 5-pin to female 3-pin adaptor may be required. Lead the data cable from the controller to the first fixture and plug it into the male data cable.
- 2 Connect the output of the fixture closest to the controller to the input of the next fixture. Continue in this manner. Up to 32 fixtures may be connected output to input.
- 3 Terminate the link as described above, at the output of the last fixture in the chain.



# Fixture settings

This section describes how to set the control address, clock, and other fixture personalities. There are three ways to define fixture settings:

## Multi-Utility Manager

Multi-Utility Manager (MUM) is a PC software application supplied with a DABS1 USB-to-XLR communications adaptor. We recommend MUM because it provides an intuitive, easy-to-use, graphical user interface.

One limitation with MUM is that you can only connect to, and set-up, one fixture at a time.

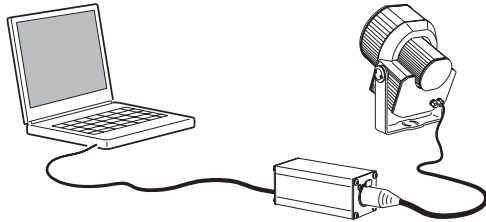

See “Defining fixture settings using MUM” on page 18.

## Martin MP-2 Uploader

This hardware uploader can be loaded with the Exterior 200’s control software and connected to the fixture or data link. (Please refer to the MP-2 Uploader user manual for details on how to do this).

When working with multiple fixtures an MP-2 allows you to apply settings globally to multiple fixtures on a data link.

The MP-2 provides a text-based interface and the fixtures do not provide feedback to the uploader. Therefore, the current settings of the fixture can only be “read” by observing the behavior of the fixture.

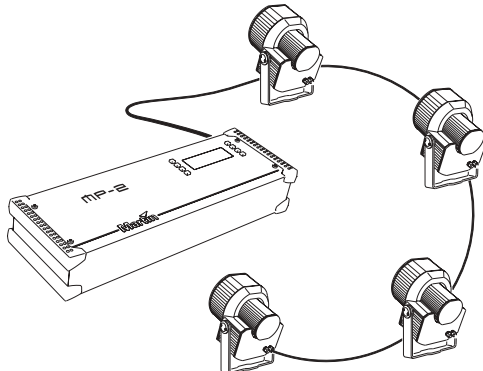

See “Defining fixture settings using an MP-2” on page 21.

## DMX Address Device

DMX Address Device (DAD) is a hardware device that can be used to set the DMX address of one Exterior 200 at a time.

If you need to set other fixture setting - such as the internal clock - then you will also need to use an MP-2 or MUM to completely set-up the fixture.

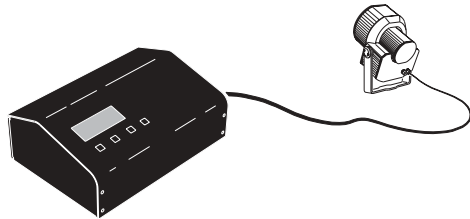

Refer to the *DMX Address Device user manual* for more information.

## Defining fixture settings using MUM

---

Using the MUM you can connect to and set up one fixture at a time. Refer to the *MUM user manual* for instructions on installing and starting the MUM application.

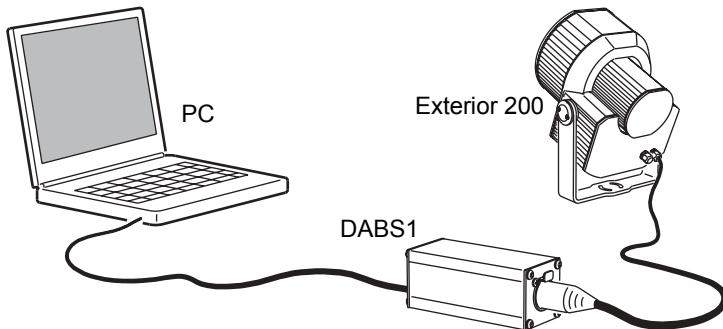

Support for the MUM application is available from Version 2 of the Exterior 200 software.

To get started:

- 1 Connect a DABS1 adaptor to your PC.
- 2 Connect the DABS1 adaptor to your Exterior 200.
- 3 Power on the Exterior 200 and start the MUM application. The application will automatically detect an Exterior 200 if it is powered-on and connected to your computer via a DABS1 adaptor. It will also retrieve the current settings on the fixture and display them.

# Clock

The Exterior 200 has a battery operated 24-hour clock that can start and stop stand-alone operation.

To set the clock:

- 1 Using MUM, click on the **Fixture information** button:

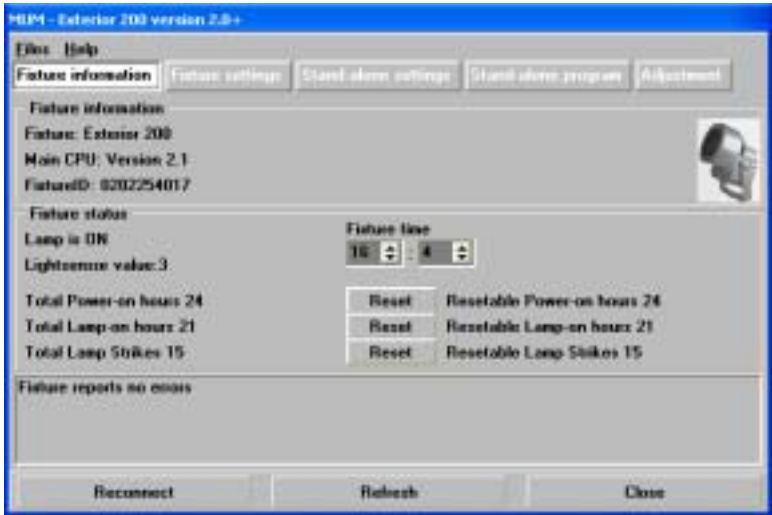

- 2 Using the two **Fixture time** spin buttons set the fixture to the current time (expressed in the 24-hour clock in hours and minutes). The time will be updated in the fixture in real-time.

# Fixture settings

To set the additional fixture settings, click on the **Fixture settings** button:

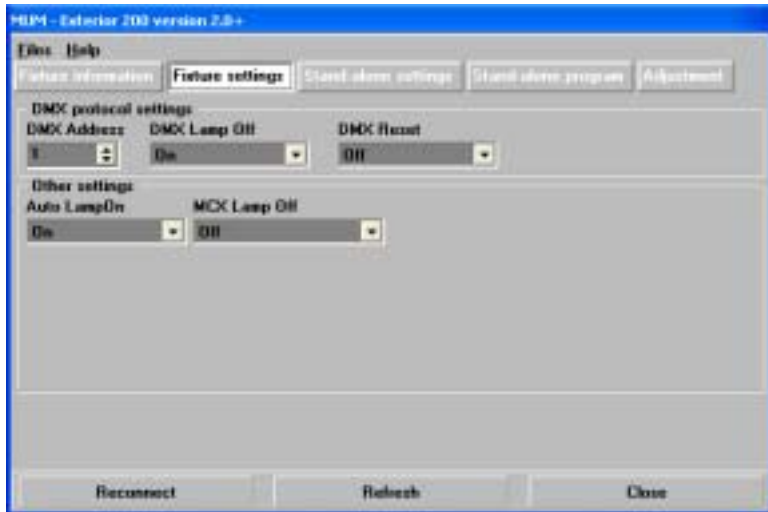

## DMX address

The DMX address, also known as the control address, or start channel, is the first channel used to receive instructions from the controller. Each fixture needs its own control address set, and uses this address and subsequent control channels to receive instructions from a controller. The Exterior 200 uses seven control channels.

The control address, also known as the start channel, is the first channel used. The Exterior 200 uses seven channels of control data. It reads the data on the start channel and the next six channels. If the control address is set to 100, the fixture uses channels 100, 101, 102, 103, 104, 105, and 106. Channel 107 would be the control address for the next fixture.

If two or more fixtures are set up with the same address, they will receive the same instructions and should behave identically. Setting up identical fixtures with the same address is a good tool for troubleshooting unexpected behavior and an easy way to achieve synchronized action.

To set the DMX address use the **DMX Address** spin button. The fixture address is updated in real time.

## DMX Lamp Off

When the DMX Lamp-off personality is on (the default setting), lamp power can be turned off from the controller by setting channel 1 to a decimal value

from 248 to 255. When set to off, the lamp-off command executes only if channels 3, 4, and 5 are set to values from 230 to 232.

### DMX Reset

When the DMX Reset personality is on (the default setting), the fixture can be reset from the controller by setting channel 1 to a decimal value from 208 to 217. When set to off, the reset command executes only if channels 3, 4, and 5 are set to values from 230 to 232.

### Automatic Lamp On

When the **Automatic Lamp On** personality is on, the fixture turns on the lamp within 90 seconds of power on. When set to off (the default setting), a lamp-on command is required to turn on the lamp.

### MC-X Lamp Off

By choosing the option **MCX Preset 7 Key** from the **MCX Lamp off** field you enable button 7 on an MC-X controller to be used to control the lamp off function.

## Defining fixture settings using an MP-2

---

This hardware uploader can be loaded with the Exterior 200's control software and connected to a fixture or data link. (Please refer to the MP-2 Uploader user manual for details on how to do this).

When working with multiple fixtures an MP-2 allows you to apply settings globally to multiple fixtures on a data link.

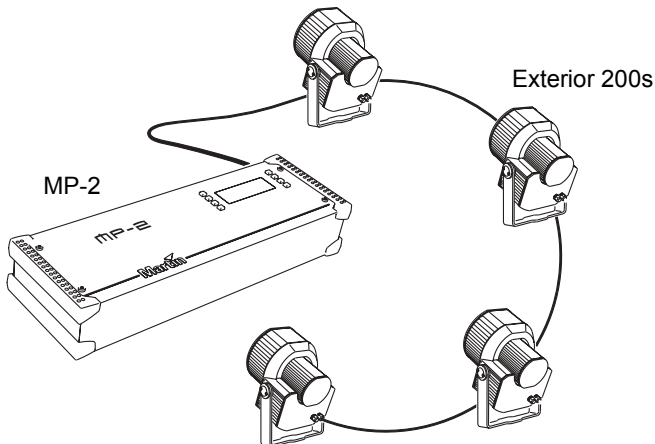

The MP-2 provides a text-based interface and the fixtures do not provide feedback to the uploader. Therefore, the current settings of the fixture can only be “read” by observing the behavior of the fixture.

## Modes

The uploader provides two ways to access fixtures: single-fixture mode and all-fixtures mode. In single-fixture mode, the uploader communicates only with the fixture at a designated address. In all-fixtures mode, the uploader communicates with all fixtures, of the same type, to which it is connected.

Fixture-specific settings such as the control address should be made in single-fixture mode. If no other fixtures are connected, however, then all-fixtures mode may be used. Global settings are made easiest in all-fixtures mode.

## DMX address

The DMX address, also known as the control address, or start channel, is the first channel used to receive instructions from the controller. Each fixture needs its own control address set, and uses this address and subsequent control channels to receive instructions from a controller. The Exterior 200 uses seven control channels.

The control address, also known as the start channel, is the first channel used. The Exterior 200 uses seven channels of control data. It reads the data on the start channel and the next six channels. If the control address is set to 100, the fixture uses channels 100, 101, 102, 103, 104, 105, and 106. Channel 107 would be the control address for the next fixture.

If two or more fixtures are set up with the same address, they will receive the same instructions and should behave identically. Setting up identical fixtures with the same address is a good tool for troubleshooting unexpected behavior and an easy way to achieve synchronized action.

***Important!*** ***When setting the address, either use single-fixture mode or isolate all other fixtures from the uploader.***

To set the control address:

- 1 Prepare an upload device as described in the uploader user manual. If you know the address to which the fixture is currently set, that is, the address to change *from*, connect the uploader to the data link and use single-fixture mode. Otherwise, use all -fixtures mode and isolate all other fixtures from the uploader. Apply power to the fixture.
- 2 If using single-fixture mode, scroll to the fixture’s current (from) address and press OK.

- 3 Select `DMX address` from the fixture menu.
- 4 Scroll to the desired control address and press OK.
- 5 Press OK again to confirm and save the setting.

## Personality settings

The following settings are available to modify fixture behavior.

**DMX Lamp-off:** When the DMX Lamp-off personality is on (the default setting), lamp power can be turned off from the controller by setting channel 1 to a decimal value from 248 to 255. When set to off, the lamp-off command executes only if channels 3, 4, and 5 are set to values from 230 to 232.

**DMX reset:** When the DMX Reset personality is on (the default setting), the fixture can be reset from the controller by setting channel 1 to a decimal value from 208 to 217. When set to off, the reset command executes only if channels 3, 4, and 5 are set to values from 230 to 232.

**Automatic Lamp-on:** When the Automatic Lamp-on personality is on, the fixture turns on the lamp within 90 seconds of power on. When set to off (the default setting), a lamp-on command is required to turn on the lamp.

To set a personality setting:

- 1 Prepare and connect an upload device as described in the uploader user manual. Apply power to the fixture.
- 2 Select single fixture mode to change a setting on a single fixture, or all-fixtures mode to make global changes.
- 3 If using single-fixture mode, enter the fixture's address.
- 4 Select `Special` from the fixture menu.
- 5 Select the desired personality and setting. (See "MP-2 control menu structure" on page 66.) Press OK.

## Clock

The Exterior 200 has a battery operated 24-hour clock that can start and stop stand-alone operation.

To set the clock:

- 1 Prepare and connect an upload device as described in the MP2 Uploader manual. Apply power to the fixture.
- 2 Select all-fixtures mode.
- 3 Select `Time` from the fixture menu.

- 4 Select `Hour` and scroll to the current hour.
- 5 Press `OK`.
- 6 Select `Minute` and scroll to the current minute.
- 7 Press `OK`.
- 8 Press `Back` to return to the main menu.



# General operation

## General guidelines

---

When the Exterior 200 is connected to power it will reset.

For optimum lamp life, turn off lamp power whenever illumination is not required for extended periods of an hour or more. Fixture power may remain on when not in use.

When the temperature is expected to fall below freezing, leave the fixture powered on when not in use to keep the electronics warm. The lamp, however, may be switched off.

Always allow the lamp to warm up fully before turning it off.

Avoid turning on several lamps at once.

## The LEDs and fixture operating status

---

Two LEDs on the rear panel display the fixture status. Normal operation is indicated by two green LEDs. See Table 4 for other status messages.

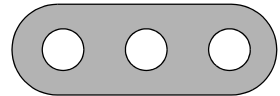

The LEDs flash off for a brief instant at regular intervals to prevent false readings when the light sensor samples the light level.

LED 1    LED 2    SENSOR

Appearance	Message, LED 1	Message, LED 2
Steady green	Effects OK	Data OK.
Steady red	-	Invalid data/no data
Steady yellow	Upload in progress	Upload in progress
Blink red	Memory error	-
Blink yellow	Reset in progress	Reset in progress

Table 4: LED status messages

Appearance	Message, LED 1	Message, LED 2
Off	-	No data detected

**Table 4: LED status messages**

The three-digit version number (*major.minor.build*) of the installed firmware is displayed by the LEDs on power up; the number of:

- Red flashes in LED 1 indicate the major number, followed by,
- Green flashes in LED 2 indicate the minor number, followed by,
- Red flashes in LED 2 indicate the build number (only used for beta releases)

For example, if the firmware version is 1.3.0, LED 1 flashes red once and LED 2 flashes green three times.

## Fixture control methods

---

The Exterior 200 can be controlled:

- With DMX signals from a DMX control device such as a DMX recorder or DMX controller. This is described in “Section 3. DMX control” on page 49.
- Using stand-alone programming. There are two ways of programming and storing a show in the fixture itself:
  - 1 From a personal computer, using the Martin MUM software application, or
  - 2 Via an MP-2 Uploader

Stand-Alone programming is described in “Section 2. Stand-Alone operation” on page 27.

# SECTION 2. STAND-ALONE OPERATION

# Stand-Alone programming overview

Stand-alone is a mode where the fixture executes color changes at set intervals and speeds, at pre-defined periods during the day, and/or when the light level falls below a defined level. The term *stand-alone* is used to mean that the Exterior 200 is not connected to a control device, but is pre-programmed with a series of up to 20 scenes that play continuously in a loop. The term 'stand-alone operation' can be applied to a single fixture, or to multiple fixtures operating synchronously.

An Exterior 200 running a stand-alone show can perform synchronized scene changes (triggered by a master fixture) with up to 31 other Martin fixtures of the following types:

- Exterior 200
- Exterior 600
- FiberSource CMY150
- Imager series
- Alien 02 series
- MiniMAC Maestro

These fixtures all have their own shows individually programmed, but have scenes synchronously triggered by a one fixture. Synchronous operation of multiple fixtures requires that they be connected on a data link.

## About scene timing

---

Each scene has a dynamic part - the fade - during which effects move to the scene's programmed positions, and a static part - the wait - where effects do not change.

The duration of the fade and wait is programmed individually for each scene. The fade time may be 0 - 120 seconds; the wait time may be 0 - 600 seconds. The total time it takes a scene to execute is the sum of the fade and wait times.

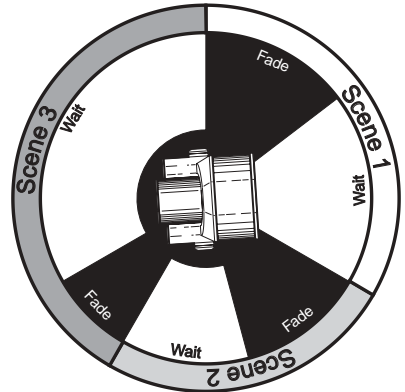

When operating multiple fixtures synchronously, the wait time is determined by the fixture that issues scene change commands. It does this when it reaches the end of each scene wait time. Every other fixture fades and waits at its own rate and then remains in the "wait state" until receiving a start scene xx command. When programming in synchronous triggering situations, keep in mind that in order to keep things as simple as possible there are two rules of thumb that will make life much easier; try to ensure that:

- 1 Every fixture has the same number of scenes.
- 2 Respective scene times are a few seconds longer on the fixture that issues triggering commands.

The rules used in the algorithm are detailed in "Synchronous triggering during Stand-Alone operation" on page 46.

## Synchronizing scene changes for multiple Exterior 200s

---

In situations where you are running multiple Exterior 200s on a data link it is possible to synchronize scene changes.

It is important to note that each individual fixture must be programmed with a show and that the only commands that are passed are scene change commands. No data about the look of the scene is passed between fixtures.

# Programming methods

---

The Exterior 200 provides two stand-alone programming methods; using the:

- Martin MUM application from a personal computer (recommend because it provides an intuitive, easy-to-use, graphical user interface), or an
- MP-2 Upload device. See the “Programming using an MP-2 Uploader” on page 37 for further information.

If you are programming a group of fixtures to perform the same scenes with synchronized-triggering then we recommend that you either:

- Use an MP-2 Uploader to program the same show on all the fixtures on the network simultaneously (and then you can assign their individual DMX address afterwards), or
- Use MUM to program a single fixture, download and save the fixture settings to a file on your PC, and then upload the stand-alone program and fixture settings to each subsequent fixture that you connect to.

# Programming from a PC using MUM

The programming of scenes, and setting up of master/slave relationships, can be performed from a personal computer using the MUM application. The computer is connected to a fixture via a DABS1 USB-to-XLR adaptor, used to program the stand-alone settings for that fixture, and then removed. Once a fixture is subsequently switched on it can automatically run the scenes in its program in a loop, according to the triggering criteria you have specified (time of day, and/or light level).

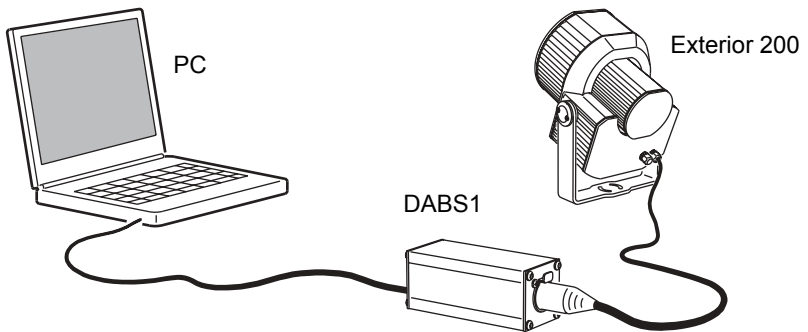

If you are not familiar with the use of MUM, then it is recommend that you familiarize yourself with it by reading the *MUM user manual*.

## Getting started

---

To get started:

- 1 Connect a DABS1 adaptor to your PC.
- 2 Connect the DABS1 adaptor to your Exterior 200.
- 3 Power on the Exterior 200 and start the MUM application. The application will automatically detect an Exterior 200 if it is powered-on and connected to your computer via a DABS1 adaptor. It will also retrieve the current settings on the fixture and display them.

# Stand-Alone Settings

The fixture needs to be configured to know if and when to activate a stand-alone program:

Click **Stand-alone settings** to display the following window.

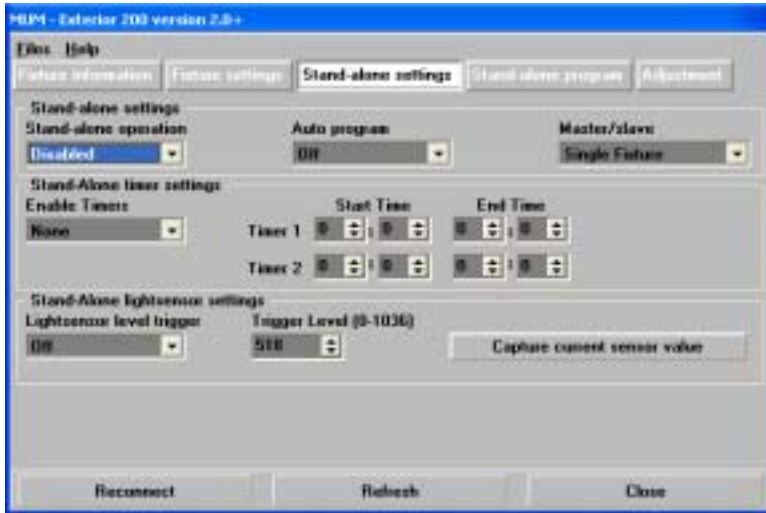

The following options are available:

- |  |   |
|--|---|
| <b>Stand-alone operation</b>             | Activates or deactivates stand-alone operation.   |
| <b>Auto program</b>                      | Enables the stand-alone program to start automatically when the fixture is powered-on. This will also cause the fixture to resume stand-alone operation if a DMX signal is disconnected.  |
| <b>Master/slave</b>                      | Specifies if the fixture is a single, “master” (triggering), or “slave” (receiving trigger signals) fixture.<br><i>No more than one fixture may be the master. Any fixture on the link, however, regardless of its position, may be the master. All other fixtures must be set as slave fixtures:</i> |
| <b>Stand-alone timer settings</b>        | See “Setting a timer trigger” on page 33  |
| <b>Stand-alone light sensor settings</b> | “Setting a light-level trigger” on page 33  |



# Synchronizing scene changes for multiple Exterior 200s

In situations where you are running multiple fixtures on a data link it is possible to synchronize scene changes (for fixtures that support this functionality - see “Introduction” on page 6). Read this section if this applies in your case.

One controlling fixture triggers simultaneous program start and scene changes in the other fixtures. Each fixture stores its own program, and the controlling fixture triggers simultaneous program start and scene changes, in a cycle, based on its own program.

Each fixture will run its program repeatedly, changing scene when prompted to by the controlling fixture, or until the controlling fixture finishes its own program and signals that all fixtures should start from the first scene once again.

It is important to note that each individual fixture must be programmed with a show and that the only commands that are passed are scene change commands. No data about the look of the scene is passed between fixtures.

## Automatically triggering stand-alone operation

Stand-alone operation can be set for one or two periods during a 24 hour period, or for a light level.

### Setting a light-level trigger

The option **Lightlevel sensor trigger** must be set to **On**.

Stand-alone operation can be set for a specific light level using the **Trigger level** spin button, or captured using the built-in light sensor (press **Capture current sensor value** to do this). If the light levels fall below the specified level then operation starts.

If both the timer *and* the light-level trigger are used, operation starts whenever it is darker than the light-level setting, and within the times set.

To avoid false triggering by sudden light changes, for example from automobile headlights, the light level must remain above or below the trigger threshold for 5 minutes.

### Setting a timer trigger

Stand-alone operation can be set for one, or two, periods, during a 24 hour period, using the built-in clock.

If both the clock *and* the light sensor are used, operation starts, within the times set, and whenever it is darker than the light-level setting. Operation stops at the stop time provided that the ambient light is brighter than the light-trigger setting.

The first thing to do is to set the correct time. See “Clock” on page 19.

You can set timer operation for a single period, or for two periods, for example, one period in the morning, and one period in the evening.

## Programming effects in scenes

---

The programming of effects is performed using the Stand-Alone program controls:

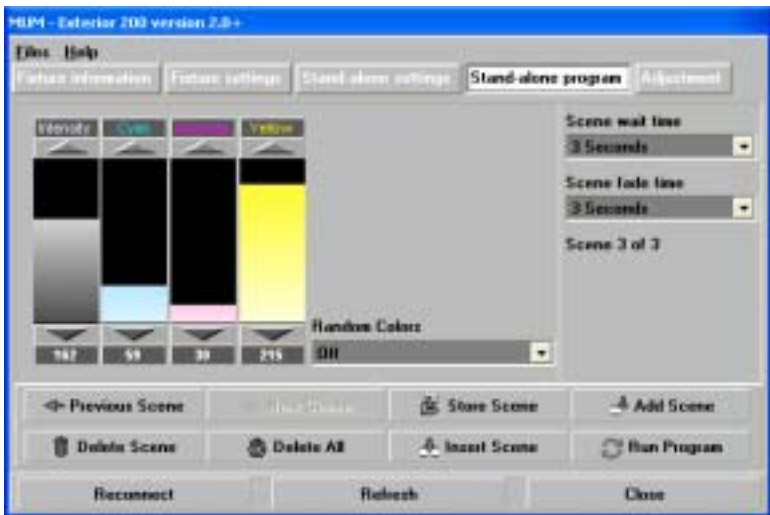

The following options are available:

**Intensity**            The dimmer level.

**Cyan**  
**Magenta**  
**Yellow**                The color.

**Random colors**        A continuously changing and random mix of all three, or any two of the primary subtractive colors (CMY). The speed of the effect can be set to slow, medium, or fast.

**Scene fade time**        The fade time, anything from 0 to 120 seconds, is the time it takes to change from one color to another. If the fade time and wait time are the same, the colors change continuously.

<b>Scene wait time</b>	This is the duration a color is applied. A wait time can be from 1 second to 12 hours.
<b>Random colors</b>	A range of continuously changing color combinations.

When operating multiple fixtures in synchronized-triggering mode, the wait time in “slave” fixtures is disregarded, and is determined by the triggering, or “master” fixture. Each fixture fades at its own rate and then waits for the master to signal a scene, or program, start before continuing.

When programming a triggering (“master”) fixture, keep in mind that its total scene times should be equal to or longer than the fade times of the other fixtures. You will get unpredictable results if, for example, a scene is programmed in the master to last 10 seconds and in other fixtures to fade for 15 seconds.

## Scene management

Once you have specified a mix of effects, you can store the scene using the options available under the Program menu:

<b>Store scene</b>	Save settings in the current scene.
<b>Add scene</b>	Save settings in a new scene at the end of the sequence.
<b>Insert scene</b>	Save settings in a new scene before the current scene, which moves up a number. <i>Tip: Think of the Add and Insert commands as Save commands, to be used as the last step after programming all effects.</i>
<b>Delete scene</b>	Remove the current scene from memory. Scenes above the deleted scene move down a number.
<b>Next scene</b>	Step to the next scene.
<b>Previous scene</b>	Step to the previous scene.
<b>Delete all</b>	Remove all scenes from the fixture memory.
<b>Run program</b>	Run the scenes in the current program.

When the program is run, scenes execute in a continuous, ascending loop.

Note that, if a “slave” fixture has:

- Fewer scenes than the master fixture, it will run these in a cycle continuously, until the master fixture signals that the program should start from the beginning again.
- More scenes than the master fixture, then the additional scenes will never run, because the program will reset to the first scene when the master starts its program from the beginning.

## **Programming the same stand-alone show on multiple fixtures**

---

Although you can only connect to and program a single fixture at a time using the MUM, you can use it to program a single fixture, download and save the fixture settings to a file on your PC, and then upload the stand-alone program and fixture settings to each subsequent fixture that you connect to. This is useful if you have a group of fixtures that will run the same stand-alone show.

# Programming using an MP-2 Uploader

The programming of scenes, and setting up of master/slave relationships, can be performed using an MP-2 Uploader. The uploader is connected to the fixture, used to program the stand-alone settings for that fixture (or all the fixtures connected to that fixture by data link), and then removed. Once a fixture is subsequently switched on it can automatically run the scenes in its program in a loop, according to the triggering criteria you have specified (time of day, or light level).

To summarize, you can use the MP-2 Uploader to program:

- Individual fixtures, one at a time.
- The same program in multiple fixtures that are linked with data cables.
- Individual programs in multiple fixtures that are linked with data cables.

If you are not familiar with the use of the MP-2, then it is recommend that you familiarize yourself with it using the MP-2 Uploader manual.

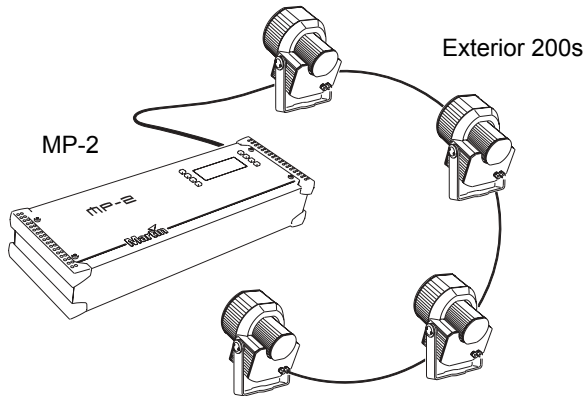

## Getting started

---

- 1 Plug the fixture's, or data link's, data-input cable (male) into the 3-pin "DMX/RS-485 OUT" socket on the MP-2.
- 2 Apply power to the fixture and the MP-2.
- 3 Select `Read Memory Card` from the MP-2 menu.

- 4 Select `EXT200 ver. x.x`. (Note that `x.x` is the number that corresponds to the firmware level that is loaded in the fixture. The installed firmware version number is displayed by the LEDs on power up. The number of red flashes in LED 1 indicates the digit to the left of the decimal point and the number of green flashes in LED 2 indicates the digit to the right of the decimal point. For example, if the firmware version is 1.3, LED 1 flashes red once and LED 2 flashes green three times.)
- 5 Select `Fixture menu`. It is from this point you use the keys on the uploader to navigate and select the desired menu item. For further guidance see the following sections.

## Selecting fixtures to program

---

Before selecting any fixture to program you must have set its control address. If you have not yet done so, follow the instructions described in “DMX address” on page 22.

You have the option of programming all the Exterior 200s on a data link, or an individual Exterior 200. Fixture-specific settings such as the control address should be made in single-fixture mode. If no other fixtures are connected, however, then all-fixtures mode may be used. Global settings are made easiest in all-fixtures mode. For example, it might be appropriate to program the time, or trigger criteria into all fixtures simultaneously, while program scenes might be programmed into fixtures individually.

Note that it is important that all the fixtures have the same software level set, or the results will be unpredictable. For more information see, “Firmware updates” on page 60.

### Selecting a single fixture

To program a single fixture:

- 1 Select `Single address` from the Fixture menu.
- 2 Select a start address that corresponds to the fixture that you want to program using the arrows.
- 3 Select `OK`.

### Selecting all Fixtures on a data link

To program all fixtures on the data link simultaneously, select `All addresses` from the Fixture menu.

# Enabling or disabling stand-alone mode

---

To:

- Disable stand-alone mode, select `Stand alone`, then `Enable SA`, and then `Off`.
- Enable stand-alone mode, select `Stand alone`, then `Enable SA`, and then `On`.

Stand-alone mode can be disabled temporarily by:

- Turning the fixture off.
- Connecting a controller and sending control signals.

Stand-alone operation resumes, when the fixture has been turned off and then turned back on again, provided that the `Auto prog. on` option has been specified for the fixture (for more information see “Automatic program start at power-on” on page 43), or when another trigger event occurs (light-level or time trigger).

## Synchronizing scene changes for multiple Exterior 200s

---

In situations where you are running multiple Exterior 200s on a data link it is possible to synchronize scene changes. Read this section if this applies in your case.

One controlling fixture triggers simultaneous program start and scene changes in the other fixtures. Each fixture stores its own program, and the controlling fixture triggers simultaneous program start and scene changes, in a cycle, based on its own program.

Each fixture will run its program repeatedly, changing scene when prompted to by the controlling fixture, or until the controlling fixture finishes its own program and signals that all fixtures should start from the first scene once again.

It is important to note that each individual fixture must be programmed with a show and that the only commands that are passed are scene change commands. No data about the look of the scene is passed between fixtures.

## Setting synchronized triggering options

- 1 Scroll to `SA` in the top level of the menus on the control panel and press [enter].

- 2 Scroll to `SAE` and press [enter].
- 3 Select:
  - `Sin` If the fixture will operate in isolation (with no synchronous triggering). This is the factory default setting.
  - `Snd` If the fixture will send scene triggering signals to the other Exterior 200s on the data link.
  - `Syn` If the fixture should “listen” for scene trigger signals on the data link.
- 4 Press [enter].

### Defining a master fixture

*No more than one fixture may be the master.* Any fixture on the link, however, regardless of its position, may be the master.

- 1 From the `Stand alone` menu, select `Master/slave`.
- 2 Select `Master`. This designates the fixture as the master fixture and causes it to transmit synchronization signals to the slave fixtures when its program runs.

### Defining slave fixtures

All other fixtures must be set as slave fixtures:

- 1 From the `Stand alone` menu, select `Master/slave`.
- 2 Select `Slave`. This designates the fixture as a slave fixture which will respond to synchronization signals received from the master fixture.

## Automatically triggering stand-alone operation

---

Stand-alone operation can be set for one or two periods during a 24 hour period, or for a light level.

### Setting a light-level trigger

Stand-alone operation can be set for a light level using the built-in light sensor. If the light levels fall below the specified level then operation starts.

If both the timer *and* the light-level trigger are used, operation starts whenever it is darker than the light-level setting, and within the times set.



To avoid false triggering by sudden light changes, for example from automobile headlights, the light level must remain above or below the trigger threshold for 5 minutes.

To set the light trigger:

- 1 From the `Stand alone` menu, select `Light level`, then `Enable`, and then `On`.
- 2 Select `Level` and use the arrow keys to select a trigger level from 0 (darkest) to 255 (brightest). The light toggles on and off as you scroll past the current light level.
- 3 Select `OK`.

Alternatively, you could capture the current light level using the sensor in the fixture, and use this as the trigger level:

- 1 From the `Stand alone` menu, select `Light level`, then `Enable`, and then `On`.
- 2 Select `Capture` and then select `Go`.

## Setting a timer trigger

Stand-alone operation can be set for one, or two, periods, during a 24 hour period, using the built-in clock.

If both the clock *and* the light sensor are used, operation starts, within the times set, and whenever it is darker than the light-level setting. Operation stops at the stop time provided that the ambient light is brighter than the light-trigger setting.

The first thing to do is to set the correct time. See “Clock” on page 23.

You can set timer operation for a single period, or for two periods, for example, one period in the morning, and one period in the evening. To set the timer for a single period:

- 1 Select `Stand alone` from the Fixture menu.
- 2 Select `Timer`, then `Timer 1`
- 3 Select `Start`, then `Hour`. Use the arrow keys to specify the start hour. Select `OK`.
- 4 Select `Minute`. Use the arrow keys to specify the start minute. Select `OK`.
- 5 Select `Back`.
- 6 Select `Stop`, then `Hour`. Use the arrow keys to specify the stop hour. Select `OK`.

- 7 Select `Start`, then `Minute`. Use the arrow keys to specify the stop minute. Select `OK`.

## Programming effects in scenes

---

The programming of effects is performed using the stand alone Program menu options, such as:

<code>Dimmer</code>	The dimmer level.
<code>Cyan</code> <code>Magenta</code> <code>Yellow</code>	The color.
<code>Random colors</code>	A continuously changing and random mix of all three, or any two of the primary subtractive colors (CMY). The speed of the effect can be set to slow, medium, or fast.
<code>Fade time</code>	The fade time, anything from 0 to 120 seconds, is the time it takes to change from one color to another. If the fade time and wait time are the same, the colors change continuously.
<code>Wait time</code>	This is the duration a color is applied. A wait time can be from 1 second to 12 hours.

When operating multiple fixtures in master/slave mode, the wait time in slave fixtures is disregarded, and is determined by the master fixture. Each fixture fades at its own rate and then waits for the master to signal a scene, or program, start before continuing.

When programming a master fixture, keep in mind that its total scene times should be equal to or longer than the fade times of the other fixtures. You will get unpredictable results if, for example, a scene is programmed in the master to last 10 seconds and in other fixtures to fade for 15 seconds.

## Scene management

Once you have specified a mix of effects, you can store the scene using the options available under the Program menu:

<code>Store scene</code>	Save settings in the current scene.
<code>Add scene</code>	Save settings in a new scene at the end of the sequence.
<code>Insert scene</code>	Save settings in a new scene before the current scene, which moves up a number. <i>Tip: Think of the Add and Insert commands as Save commands, to be used as the last step after programming all effects.</i>

Delete scene	Remove the current scene from memory. Scenes above the deleted scene move down a number.
Next scene	Step to the next scene.
Previous scene	Step to the previous scene.
Clear scenes	Remove all scenes from the fixture memory.
Run program	Run the scenes in the current program.

The only indication of what the current scene is comes from the behavior of the fixture.

When the program is run, scenes execute in a continuous, ascending loop.

If a slaved fixture has:

- Fewer scenes than the master fixture, it will run these in a cycle continuously, until the master fixture signals that the program should start from the beginning again.
- More scenes than the master fixture, then the additional scenes will never run, because the program will reset to the first scene when the master starts its program from the beginning.

## Automatic program start at power-on

---

You can specify that the program should start automatically when the fixture is powered-on. From the Stand alone menu select `Auto prog. on.` Then select `On.`

This will also cause the fixture to resume stand-alone operation if a DMX signal is disconnected.

## Disconnecting the MP-2 Uploader

---

When all the settings have been made, disconnect the data input cable from the MP-2.

Reconnect the output cable to the data link, or next fixture if applicable, and run through the process described in this section.

# Stand-Alone show playback

## Starting show playback automatically at fixture power-on

---

Execution of the pre-programmed scenes in a loop will automatically resume when the fixture is powered-on if stand-alone is enabled and the automatic lamp-on function is enabled; to check or define these options, see:

- “Automatic program start at power-on” on page 43 if you have an MP-2 or,
- “Stand-Alone Settings” on page 32 if you are using MUM.

## Scene execution using the optional MC-X

---

The MC-X is an optional remote control unit that is available from Martin. Once the remote controller is connected, 7 scenes can be conveniently called up on the MC-X's buttons.

## Enabling MC-X control

### Using an MP-2

For each fixture:

- 1 Disable stand-alone operation on each fixture, select `SA / run / OFF` and press [enter]. Press [menu] to exit the SA menu.
- 2 Using the `Per / nno` menu it is possible to set button 7 on the MC-X to control the lamp off function. See “MP-2 control menu structure” on page 66.

### Using MUM

For each fixture:

- 1 Disable stand-alone operation. See “Stand-Alone Settings” on page 32, under the chapter “Programming from a PC using MUM”.
- 2 Enable lamp-on from the MC-X. See “MC-X Lamp Off” on page 21 in the section “Defining fixture settings using MUM”.

## **Connecting and using the MC-X Controller**

- 1 Connect the MC-X controller to the Exterior 200's data network via an XLR-to-RJ-45 adaptor. If multiple Exterior 200s are connected, plug the controller into the first fixture in the link.
- 2 To trigger scenes 00-06, press the numbered preset buttons on the MC-X.
- 3 To have each fixture run its own routine, press [Auto].

## **DMX controller override during stand-alone show playback**

---

If an Exterior 200 is connected to a DMX controller and receives DMX signals during show playback, the Stand-Alone show will stop running and the fixture will respond to the DMX controller. DMX signals always have priority over the running of a Stand-Alone show.

# Synchronous triggering during Stand-Alone operation

**Note**      *This chapter details the rules that are used in Stand-Alone synchronous triggering. It is not necessary to read this chapter unless you require help with problem diagnosis or unless you otherwise need a detailed understanding of the algorithm used for synchronous triggering.*

The rules are as follows:

- 1 Every fixture can have up to 20 on-board scenes with individual fade and wait times.
- 2 Scenes are numbered from 0 to 19.
- 3 A scene contains a fade-section, followed by a wait-section.
- 4 When running "synchronous triggering" one Exterior 200 issues commands to the other Exterior 200s to "go to scene xx", where xx is the scene number that master will execute next.
- 5 If a slave has fewer scenes than the master, it will derive which scene to go to by dividing the number of the scene it has been commanded to go to (scene 5, for example) by the total number of scenes that the slave fixture has (4, for example) in whole numbers (no decimal places). In this example 5 divided by 4 results in 1, with 1 remainder. This remainder will be the number of the scene that the slave fixture starts - scene 1. Generally though, when a Slave fixture reaches its own last scene before the Master fixture, a "go to scene x" message will result in the first scene being played.

- 6 If a slave has more scenes than the master calls, the last scenes in the slave will never be executed, as is the case with scene S4 in the following example.

F=fade, W=wait      Timeline =>

Programmed in Master	M0	M1	M2	M3	
	F   W	F   W	F   W	F   W	
Programmed in Slave	S0	S1	S2	S3	S4
	F   W	F   W	F   W	F   W	F   W
Result	M0	M1	M2	M3	
	F   W	F   W	F   W	F   W	
	S0	S1	S2	S3	
	F   W	F   W	F   W	-- -- F   W	

- 7 A slave fixture will not listen for the next message from the master fixture before it has finished its current scene. This may result in a slave skipping a scene if slave has a longer scene time than master. Note that in the following example the scenes in the Slave run out of their programmed sequence because scenes 0 and 2 on the Slave are longer than the corresponding scenes on the Master.

M=master, S=slave

F=fade, W=wait      Time >

<b>Programmed</b>	M0	M1	M2		
	F   W	F   W	F   W		
Slave	S0	S1	S2		
	F   W	F   W	F   W		
<b>Result</b>	M0	M1	M2	M0	M1
	F   W	F   W	F   W	F   W	F   W
Slave	S0	S2		S1	
	F   W	F   W		.. .. F   W	.. ..





# **SECTION 3. DMX CONTROL**

# DMX Controller operation

The Exterior 200 may be programmed and operated with any lighting controller that is compatible with the USITT DMX standard. This section describes how to operate the fixture with a controller. See the DMX protocol starting on page 70 for specific control values, and “Data link” on page 15 for connection requirements.

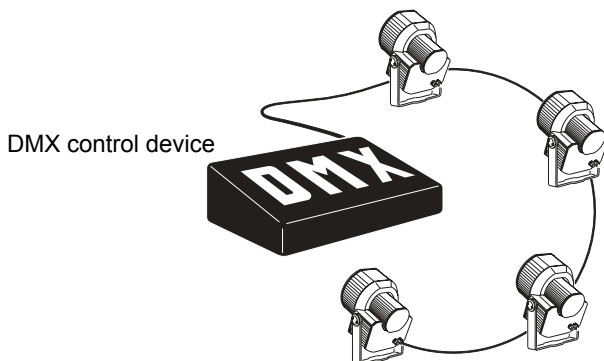

**Important:** *If an Exterior 200 is connected to a DMX controller and receives DMX signals during show playback, the stand-alone show will stop running and the fixture will respond to the DMX controller. DMX signals always have priority over the running of a stand-alone show.*

## Lamp control

---

**Important** *Avoid striking several lamps at once!*

The lamp can be turned on and off from the controller using the lamp-on and lamp-off commands on channel 1. If the DMX Lamp-off personality is off, the lamp-off command on channel 1 executes only if each of the CMY channels (3, 4, and 5) is set to a DMX value from 230 to 232.

Strike lamps one at a time at 5 second intervals. Striking many lamps at once may cause a voltage drop large enough to prevent lamps from striking, damage electronics, and trip circuit breakers. To have the lamp strike

automatically at power-up, set the Automatic Lamp-on personality to on (see page 23).

Note: After being turned off, the lamp must cool for approximately 8 minutes before it can be turned back on.

## Effects

---

The mechanical effects reset to their home positions when the fixture is powered on. Effects can also be reset from the controller on channel 1. If the DMX Reset personality is off, the reset command on channel 1 executes only if each of the CMY channels is set to a DMX value from 230 to 232.

## Dimmer

The mechanical dimmer provides smooth, high resolution, full-range dimming on channel 2.

## CMY subtractive color mixing

The CMY color mixing system is based on cyan, magenta, and yellow color filters. A continuous range of colors may be achieved by varying the amount of each filter from 0 to 100% on channels 3, 4, and 5. To execute specific color values, channel 6, random color mixing, must be set to 0%.

Note that mixing 3 colors results in a loss of light - *the light is blacked out when all 3 colors are fully applied*. For maximum brightness, mix only 2 colors at a time.

If you have Exterior 600 and Exterior 200 fixtures rigged in the same installation then refer to “Color matching Exterior 200s and 600s” on page 54.

## Random color mixing

Random color mixing at slow, medium, and fast speeds is available on channel 6. The colors can be mixed from any two, or all three, of the primary subtractive colors. Choosing a random mixing of just two of the primary subtractive colors will result in the following types of tones:

Combination	Result
Cyan & magenta	Bluish tones
Cyan & yellow	Greenish tones
Magenta & yellow	Reddish tones

These random commands take precedence over values set on the cyan, magenta, and yellow channels.

## Effect speed

The speed at which effects fade, that is, move from one position to another, can be controlled in two ways known as tracking control and vector control. You may switch between tracking and vector control, but you cannot use both at the same time.

Tracking control is enabled by setting channel 7, the speed channel, to a decimal value from 0 to 2. Fades are then programmed using the controller's cross-faders. The Exterior 200 has a digital filter algorithm that averages several updates to ensure smooth movement.

Vector control provides a way to program fades on controllers without cross-faders and may provide smoother fades than tracking control with some controllers, particularly on very slow fades. A vector speed is programmed by setting channel 7 to a decimal value from 3 (fastest) to 245 (slowest). The speed setting applies to dimmer and color fades. When using vector control, the controller cross-fade time, if available, must be 0.

# SECTION 4. OPTICS

# Color matching

## Exterior 200s and 600s

If you are running Exterior 200 and Exterior 600 fixtures together in the same installation, colors will not match when the same CMY values are used, because these fixture use difference lamps.

Generally speaking, the relatively:

- Higher-powered lamps used in the Exterior 600 result in deeper colors in the cold colors of the spectrum.
- Lower-powered lamp used in the Exterior 200 will give deeper colors in the warm colors of the spectrum.

The following table gives some approximate values for color matching:

<b>Color</b>	<b>Exterior 600 (with MSD 575 lamp)</b>	<b>Exterior 200 (with CDM lamp)</b>
White	Magenta 25 Yellow 44	Open
White	Open	Cyan 74
Yellow	Yellow 241 Magenta 16	Full yellow
Magenta	Magenta 100 Yellow 68	Full magenta
Cyan	Full cyan Magenta 25 Yellow 44	Full cyan
Red	Full magenta Full yellow	Full yellow Magenta 215
Green	Cyan 241 Yellow 241	Full cyan Full yellow
Blue	Full cyan Full magenta	Cyan 255 Magenta 191

# Lens options

Exterior 200s are available with the following factory-standard optics:

Model	Beam angle
Exterior 200	60°
Exterior 200 Long Barrel	12°
Exterior 200 Long Barrel	22°

The following optional lens are available for Exterior 200 models:

- Micro diffuser lens**      The micro diffuser lens is suitable for the standard Exterior 200. It provides a symmetric 71° field. It installs with the rough side out, away from the lamp.
- Fresnel lens**              The Fresnel lens is suitable for the standard Exterior 200. It provides a symmetric 34° field. It installs with the ridges out, away from the lamp.
- Beam shaper lens**        The beam-shaper lens provides a 83° x 91° beam angle in a standard Exterior 200 and a 14° x 69° beam angle in an Exterior 200 Long Barrel.

The lens should be installed with the ridges facing in, towards the lamp and may be turned as desired; the ridges are parallel with the short axis of the field. This lens is lighter and more fragile than the others: *be extra careful when installing the beam shaper lens and tighten the rubber washers just enough to exert light pressure.*

## Changing the lens

---

Lens installation requires a 4 mm Allen wrench and a no. 2 Pozidriv screwdriver.

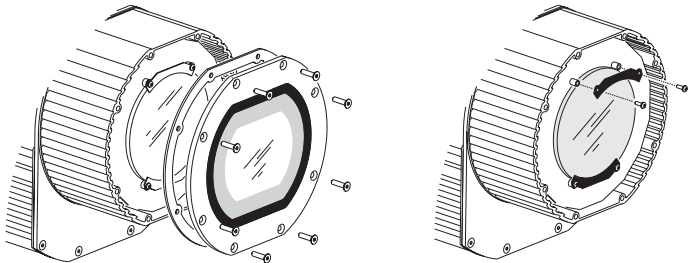

- 1 Remove the front cover and gasket. Loosen the screws in the bottom lens bracket to release the pressure in the rubber washers. Remove the top lens bracket. Remove the existing lens.
- 2 Place the new lens flat against the metal plate with the rougher side in or out as described above. Replace the top lens bracket. Tighten the 4 lens bracket screws several turns to squeeze the washers out against the lens.
- 3 To replace the front cover:
  - a Drive all screws to the bottom without tightening (finger tight).
  - b Starting with one screw and working around in a circle, tighten all screws partially, with low torque.
  - c Tighten to a maximum torque of 1.8 Nm. (1.3 Ft-Lbs), still working around in a circle. Note that if you tighten the screws to more than the maximum torque the front glass might break.



# **SECTION 5. SERVICE AND TROUBLESHOOTING**

# Service

This section describes service procedures that can be performed by the user. Refer all service not described here to a qualified Martin technician.

**Warning!** *Disconnect the fixture from power before removing any cover.*

## Seal maintenance

---

### Gaskets

To maintain the fixture's resistance to dust and moisture, it is important that you replace gaskets and covers carefully after removal. Cross-tighten all screws to a torque of 1.8 Nm (2.2 Ft-Lbs). With this torque, the seal will be compressed by about one-third. When replacing the front cover, to avoid breaking the glass, tighten the screws by working around in a circle, tightening them gradually to a maximum torque of 1.8 Nm. (1.3 Ft-Lbs).

The silicone gaskets should maintain their sealing ability for the life of the fixture. When servicing the fixture, note the condition of the gaskets and replace any gasket that is cracked, torn, brittle, or inflexible. Replacement gaskets may be ordered as follows:

Front section seal for Exterior 200/300 . . . . .	P/N 20600070
Lamp section seal for Exterior 200/300 . . . . .	P/N 20600080
Power section seal for Exterior 200/300 . . . . .	P/N 20600090

### Cable glands

The cable gland must be replaced if the power or data cable is replaced with a cable of a different diameter, or if the data cable is replaced with two separate cables. Replacement glands, available from electrical suppliers, must have the following characteristics.

Temperature range: . . . . .	-20° to 70° C or better
Ingress protection rating: . . . . .	IP 67 or 68
Entry thread size: . . . . .	PG 11
Minimum entry thread length: . . . . .	8 mm

# Lamp replacement

The Exterior 200 can use the following discharge lamps. *Installing any other lamp type may damage the fixture.*

Lamp	Efficiency	Color Temp.	Average Life
Philips CDM-SA/T 150W	85 Lm/W	4000 K	6000 hr.
Osram HSD 150/70	80 Lm/W	7000 K	2000 hr.
General Electric CMH 150	85 Lm/W	4200 K	12000 hr.

**Table 5: Lamp specifications**

Lamp replacement requires 3 mm and 4 mm Allen wrenches

**Warning!** *Allow the lamp to cool for 15 minutes before removing the lamp cover.*

To replace the lamp:

- 1 Disconnect the fixture from power and allow it to cool.
- 2 Remove the lamp cover and gasket.
- 3 Remove the Allen screws to the left and right of the lamp socket. Gently lead the lamp out of the housing.
- 4 Remove the old lamp from the socket. Holding the new lamp by its ceramic base - *do not touch the glass bulb* - insert it firmly and squarely into the lamp socket. Clean the glass bulb with an alcohol wipe or a clean, lint-free cloth wetted with alcohol.
- 5 Gently insert the lamp through the reflector opening without winding the wires around the lamp.
- 6 Replace the Allen screws. To replace the cover see “Gaskets” on page 58.

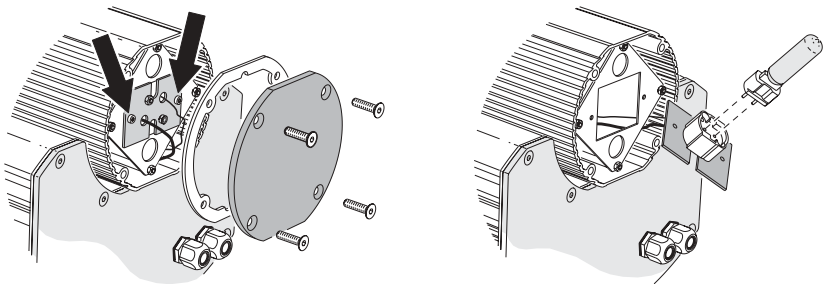

# Cleaning

---

Rinse off loose dirt with a garden hose or low pressure water spray. Wash the aluminum housing with a soft brush or sponge and a mild, non-abrasive car washing detergent. Rinse.

# Firmware updates

---

The latest Exterior 200 firmware is available from the support area of the Martin web site at <http://www.martin.com>. It can be installed using an MP-2, or via a PC serial data link using a hardware interface supported by the Software Uploader shareware (also available from the Martin web site). The following devices are currently supported (in Version 5.5):

- DABS 1 (presently available with the MUM software package)
- ShowDesigner PCI DMX Interface Card (2048 channel version)
- LightJockey PCI DMX Interface Card (512 and 2048 channel versions)
- LightJockey PCMCIA DMX Interface
- LightJockey 4064 ISA DMX Interface Card (DJ and Club versions)

Note: Intermediate control systems such as the Martin Lighting Director (MLD) and the Martin Matrix must be bypassed when updating fixture software via the DMX link. These systems do not relay the update code correctly because it is not a DMX-compliant signal.

## Normal update

To update fixture software, connect an upload device to the fixture just like a DMX controller and perform a DMX mode upload as described in the uploader's documentation. There is no need to isolate the Exterior 200s from other types of fixtures on the serial link.

When the upload is completed (and when booting up) the Exterior 200 performs a check-sum test of the memory and then resets.

In the unlikely event that a software upload is interrupted, the fixture must be powered off for at least 10 seconds to force a check-sum test. You can then repeat the DMX-mode upload. If an error occurs and the fixtures do not reset, data was interrupted or corrupted during transmission. Perform a boot sector upload as described below.

## Boot sector upload

If the normal upload procedure does not work, or if the software update notes call for a boot sector update, move the boot sector jumper at PL2 to the BOOT position before uploading software.

### Performing a boot sector update

- 1 Make sure the Exterior 200 is isolated from AC power. Open the power section.
- 2 Locate the jumper at position PL2. Move the jumper to the “BOOT” position (pins 1 and 2).
- 3 Perform a boot mode upload as described in the uploader manual.
- 4 When the upload is complete, disconnect the fixture from power and move the jumper at PL2 back to the “LOCK” position (pins 2 and 3).
- 5 To replace the cover see “Gaskets” on page 58.

## Fuse replacement

---

**Warning!** *Never replace fuses with ones of a different rating!*

The Exterior 200 has 3 fuses located in the power section. The main fuse is located on the small circuit board and the secondary fuses for the low-voltage power supplies are located on the main circuit board.

Fuse replacement requires a 4 mm Allen wrench and an 8 mm wrench.

To replace a fuse:

- 1 Make sure the Exterior 200 is isolated from AC power.
- 2 Open the power section.
- 3 Remove the two bolts at the rear of the power module and then slide the entire module out of the housing.
- 4 Locate and replace the defective fuse with one of the same size and rating.
- 5 Replace and secure the module. Replace the cover before applying power. (See “Gaskets” on page 58.)

# Printed circuit board layout

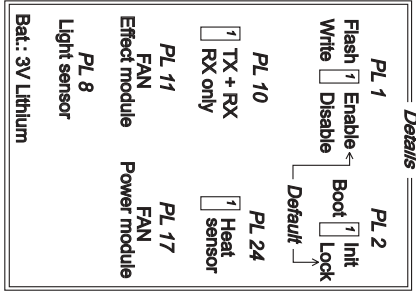

P/N 33120026-B

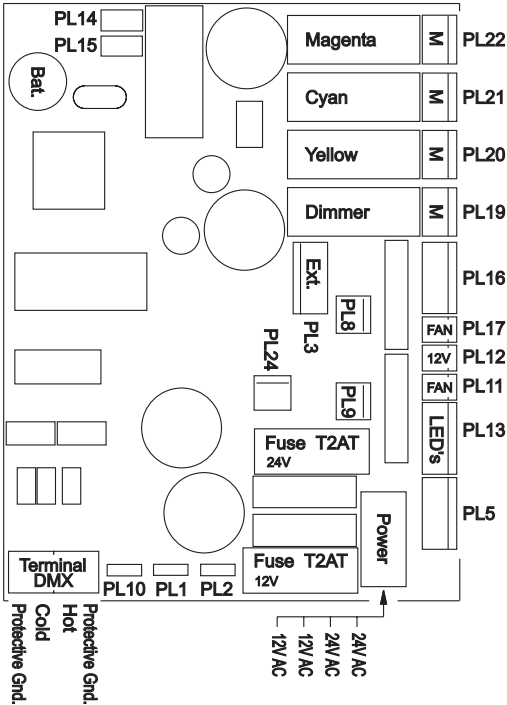

# Troubleshooting

<b>Problem</b>	<b>Probable cause(s)</b>	<b>Remedy</b>
No response from fixture when power is applied.	No power to fixture.	Check power cables.
	Primary fuse blown.	Replace fuse.
	Secondary fuse blown.	Replace fuse.
Fixture resets but does not respond correctly to controller (DMX mode operation).	Controller not connected.	Connect controller.
	Incorrect addressing of the fixtures.	Check address setting on fixture and controller.
	Bad data link connection.	Inspect cables and correct poor connections and/or broken cables.
	Conflict between tracking and vector control.	Eliminate scene cross-fade on controller or set ch. 7 to 0%.
	Data link not terminated.	Insert termination plug in output of last fixture.
	Defective fixture or 2 devices transmitting on link.	Bypass fixtures one at a time until normal operation is regained: unplug both connectors and connect them directly together.
Colors cannot be mixed.	Random color mixing is on.	Turn off random color mixing (ch. 6).
Fixture does not reset correctly.	Electronic or mechanical failure.	Contact service technician.
No light, lamp cuts out intermittently, or burns out too quickly.	Lamp missing or blown.	Disconnect fixture and replace lamp.
	Fixture or lamp is too hot.	Allow fixture to cool. If problem persists, contact service technician.





# SECTION 6. REFERENCE

# MP-2 control menu structure

Default settings appear in bold.

Level 1	Level 2	Level 3	Level 4	Level 5	Effect (default settings bold)
DMX address	1-512				Select control address.
Stand-alone	Enable SA	Off			Disable stand-alone operation.
		On			Enable stand-alone operation.
	Light level	Enable	Off		Disable light level operation.
			On		Enable light level operation.
		Level	1-255		Sets the light trigger level. 1 is darkest, 255 is brightest. When setting, light switches on/off at current level.
		Capture	Go		Capture current light level.
	Timer	Timer	None		Disable timer operation.
			Timer 1		Use timer 1 to trigger start/stop.
			Timer 2		Use timer 2 to trigger start/stop.
			Both Timers		Use timers 1 and 2 to trigger start/stop.
		Timer 1	Start	Hour	Set timer 1 start hour.
				Minute	Set timer 1 start minute.
			Stop	Hour	Set timer 1 stop hour.
				Minute	Set timer 1 stop minute.
		Timer 2	Start	Hour	Set timer 2 start hour.
				Minute	Set timer 2 start minute.
			Stop	Hour	Set timer 2 stop hour.
				Minute	Set timer 2 stop minute.
	Auto Prog. On	Off			Do not start the program at fixture power on.
		On			Start program at fixture power on.
Master/Slave	No Master/Slave			The fixture operates in isolation. This is the default.	
	Master			Set the fixture to the master in a chain of multiple fixtures.	
	Slave			Set the fixture to be a slave in a chain of multiple fixtures.	

Level 1	Level 2	Level 3	Level 4	Level 5	Effect (default settings bold)	
Stand-alone	Program	Dimmer	0-255		Set dimmer level.	
		Cyan	0-255		Set cyan level.	
		Magenta	0-255		Set magenta level.	
		Yellow	0-255		Set yellow level.	
		Random colors	Random off			Disable random color.
			CMY - slow			Random colors, slow
			CMY - medium			Random colors, medium
			CMY - fast			Random colors, fast
			Cyan/Mag - slow			Random bluish colors, slow
			Cyan/Mag - medi			Random bluish colors, medium
			Cyan/Mag - fast			Random bluish colors, fast
			Mag/Yel - slow			Random reddish colors, slow
			Mag/Yel - medi			Random reddish colors, medium
			Mag/Yel - fast			Random reddish colors, fast
			Cyan/Yel- slow			Random greenish colors, slow
			Cyan/Yel - medi			Random greenish colors, medium
			Cyan/Yel - fast			Random greenish colors, fast
			Fade time	Snap		
		1 sec - 2 min				Set scene fade time from one second up to two minutes.
		Wait (trig) time	0 s- 10 m			Set scene wait time up to 10 minutes.
		Add scene	Go			Save new scene to end of sequence.
		Next scene	Go			Call the next scene.
		Previous scene	Go			Call the previous scene.
		Store scene	Go			Save changes to current scene.
		Insert scene	Go			Save new scene before current scene.
		Delete scene	Go			Delete the current scene.
		Clr all scenes	No			Cancel command.
Yes				Delete all scenes.		
Run program	Leave			Run the scenes in the program.		
Time	Hour	0-23			Set the current hour in 24-hour time.	
	Minute	0-59			Set the current minute.	

Level 1	Level 2	Level 3	Level 4	Level 5	Effect (default settings bold)	
Adjust	Reset	On			Reset effects to home position.	
	Lamp on	On			Turn on lamp.	
	Lamp off	Off			Turn off lamp.	
	All effects	Open				Move all effects to open position.
		Closed				Move all effects to closed position.
	Dimmer	Open				Move dimmer to open position.
		Closed				Move dimmer to closed position.
	Cyan	Open				Move cyan flag to open position.
		Closed				Move cyan flag to full position.
	Magenta	Open				Move magenta flag to open position.
		Closed				Move magenta flag to full position.
	Yellow	Open				Move magenta flag to open position.
Closed					Move magenta flag to full position.	
Special	DMX lamp off	Off			Require confirmation of lamp-off. (default)	
		On			Enable lamp-off without confirmation.	
	DMX reset	Off			Require confirmation of reset command	
		On			Enable reset without confirmation. (default)	
	Auto lamp on	Off			Strike lamp from controller. (default)	
		On			Strike lamp automatically within 90 seconds of power on.	
Version	Leave				The installed firmware version number is displayed by the LEDs at the rear of the fixture. The number of red flashes in LED 1 indicates the digit to the left of the decimal point and the number of green flashes in LED 2 indicates the digit to the right of the decimal point. For example, if the firmware version is 1.3, LED 1 flashes red once and LED 2 flashes green three times.	

# DMX protocol

Start code = 0

DMX channel	Value	Percent	Function
1  * If the command is disabled, set channels 3, 4, and 5 (CMY) from 230 to 232.	0 - 207	0 - 81	<b>Reset, Lamp On/Off</b>
	208 - 217	82 - 85	Reserved (no change)
	218 - 227	85 - 89	Reset fixture*
	228 - 237	89 - 93	Reserved (no change)
	238 - 247	93 - 97	Lamp power on
	248 - 255	97 - 100	Reserved (no change) Lamp power off* <b>Note:</b> T ≥ 5 seconds
2	0 - 255	0 - 100	<b>Dimmer</b> Closed → open
3	0 - 255	0 - 100	<b>Cyan</b> White → Cyan
4	0 - 255	0 - 100	<b>Magenta</b> White → Magenta
5	0 - 255	0 - 100	<b>Yellow</b> White → Yellow
6	0 - 14	0 - 5	<b>Random Color Mixing</b>
	15 - 34	5-13	Off
	35 - 54	13-21	CMY, slow
	55 - 74	21-29	CMY, medium
	75 - 94	29-37	CMY, fast
	95 - 114	37-44	MY, slow
	115 - 134	45-52	MY, medium
	135 - 154	53-60	MY mix, fast
	155 - 174	61-68	CM, slow
	175 - 194	68-76	CM, medium
	195 - 214	76-84	CM, fast
	215 - 234	84-92	CY, slow
	235 - 255	92-255	CY, medium
7	0 - 2	0 - 1	<b>Speed</b>
	3 - 245	1 - 96	Tracking
	246 - 251	96 - 98	Fast → slow
	252 - 255	99 - 100	Reserved (no change)
			Fast

# Specifications - Exterior 200

## Physical

Length: 301 mm (11.9 in) / 431 mm (17.0 in)

Width: 310 mm (12.2 in)

Height: 402 mm (15.8 in)

Weight: 15 kg (33 lbs) / 16.6 kg (36.5 lbs)

## Source

Lamp: 150W HIT

Approved models: Philips CDM-SA/T, GE CMH 150, Osram HQI-R, Osram HSD150/70

Base: GY 12

## Control & Programming

Control options: DMX-512, stand-alone, master/slave, Martin MC-X remote control

Receiver: RS-485

Setting and addressing: MP-2, DAD, MUM

Firmware update: Serial upload (MUF)

Stand-alone trigger options: Internal real-time clock with timer and light-level sensor

Stand-alone memory: 20 scenes

Data input/output: 1.8 m (5.9 ft) trailing cable w/ 3-pin XLR male & 3-pin XLR female

Data pin out Pin 1 shield, pin 2 cold (-), pin 3 hot (+)

DMX channels: 7

## Dynamic effects

Cyan filter 0 - 100%

Magenta filter 0 - 100%

Yellow filter 0 - 100%

Dimmer 0 - 100%

## Installation

Minimum distance to combustible materials: 1 m (39 in)

Minimum distance to illuminated surfaces: 0.5 m (20 in)

## Thermal

Maximum ambient temperature: ( $T_a$ ) 40° C (104° F)

Maximum surface temperature, steady state,  $T_a = 40^\circ 90^\circ$  C (194° F)

Cooling Convection

## Maximum heat output

195 V @ 50/60 Hz 665 BTU/hour

210 V @ 50/60 Hz 716 BTU/hour

225 V @ 50/60 Hz 767 BTU/hour

245 V @ 50/60 Hz 836 BTU/hour

277 V @ 50/60 Hz 945 BTU/hour

\* These measurements have a margin of error of +/- 10%

## AC Supply

AC input: 1.8 m (5.9 ft) trailing cable w/o cord cap

Power supply options: 195/210/225/245/277 V, 50/60 Hz

Primary fuse T 3.15 A, high I<sup>2</sup>t, 250 V

Fuse F1T 2A, 250 V

Fuse F2T 2A, 250 V

## Maximum power and current

195 V @ 50/60 Hz 210 W, 1.2 A

210 V @ 50/60 Hz 220 W, 1.1 A

225 V @ 50/60 Hz 200 W, 1.0 A

245 V @ 50/60 Hz 200 W, 0.9 A

277 V @ 50/60 Hz 200 W, 0.8 A

\* These measurements have a margin of error of +/- 10%

## Construction

Housing: extruded aluminum

Finish: anodized, natural aluminum color

Front glass: 6 mm (0.24 in) anti-reflection coated

Mounting bracket: 8 mm (0.3 in) anodized aluminum

Housing-to-bracket attachment: 4 stainless steel M6 bolts, A2 DIN 933, 18.8

Protection factor: IP 65

## Listings

ETL, ETLC, CE

## Photometrics - Exterior 200

Efficiency 39%

Half peak angle 38°

One-tenth-peak angle 60°

Illuminance 12263/distance<sup>2</sup> lux

Half-peak diameter 0.64 x distance m

One-tenth-peak diameter 0.99 x distance m

Measurement conditions 230V, 50Hz, no color applied

Measurement source Philips CDM-SA/T 150W

## **Photometrics - Exterior 200 with beam-shaper lens**

Efficiency 31%

Half peak angle 41° / 46° 0/90 degrees

One-tenth-peak angle 83° / 91° 0/90 degrees

Illuminance 5647/distance<sup>2</sup> lux

Half-peak diameter 0.75 x distance m

One-tenth-peak diameter 1.38 x distance m

Measurement conditions 230V, 50Hz, no color applied

Measurement source Philips CDM-SA/T 150W

## **Photometrics - Exterior 200 with Fresnel lens**

Efficiency 38%

Half peak angle 21°

One-tenth-peak angle 34°

Illuminance 37721/distance<sup>2</sup> lux

Half-peak diameter 0.35 x distance m

One-tenth-peak diameter 0.58 x distance m

Measurement conditions 230V, 50Hz, no color applied

Measurement source Philips CDM-SA/T 150W

## **Photometrics - Exterior 200 with micro-diffuser lens**

Efficiency 40%

Half peak angle 42°

One-tenth-peak angle 71°

Illuminance 10076/distance<sup>2</sup> lux

Half-peak diameter 0.72 x distance m

One-tenth-peak diameter 1.17 x distance m

Measurement conditions 230V, 50Hz, no color applied

Measurement source Philips CDM-SA/T 150W

## **Included items**

User manual

Lamp: Philips CDM-SA/T 150 W



## **Accessories**

Fresnel lens P/N 91610022

Micro diffuser lens P/N 91610024

Beam shaper lens P/N 91610023

MC-X Controller, 220 - 245 V, 50 Hz P/N 90718200

MC-X Controller, 110 - 120 V, 60 Hz P/N 90718300

Philips CDM-SA/T 150 W lamp P/N 97010111

Snoot/barndoor kit P/N 91611031

Extensions to Snoot/barndoor kit P/N 91611032

DAD, DMX Address Device P/N 90758430

MUM, Multi Utility Manager P/N 90758090

MP-2 Uploader P/N 90758420

## **Ordering information**

Exterior 200, 60°, 230V, 50Hz P/N 90509000

Exterior 200, 60°, 245V, 50Hz P/N 90509002

Exterior 200, 60°, 210V, 60Hz P/N 90509004

Exterior 200 Long Barrel, 12°, 230V, 50Hz P/N 90509020

Exterior 200 Long Barrel, 12°, 245V, 50Hz P/N 90509022

Exterior 200 Long Barrel, 12°, 210V, 60Hz P/N 90509024

Exterior 200 Long Barrel, 22°, 230V, 50Hz P/N 90509040

Exterior 200 Long Barrel, 22°, 245V, 50Hz P/N 90509042

Exterior 200 Long Barrel, 22°, 210V, 60Hz P/N 90509044







---

[www.martin-architectural.com](http://www.martin-architectural.com) • Olof Palmes Allé 18 • 8200 Aarhus N • Denmark  
Tel: +45 8740 0000 • Fax +45 8740 0010